

# FASERFIX KS

Stable and efficient drainage channels for commercial and public areas.

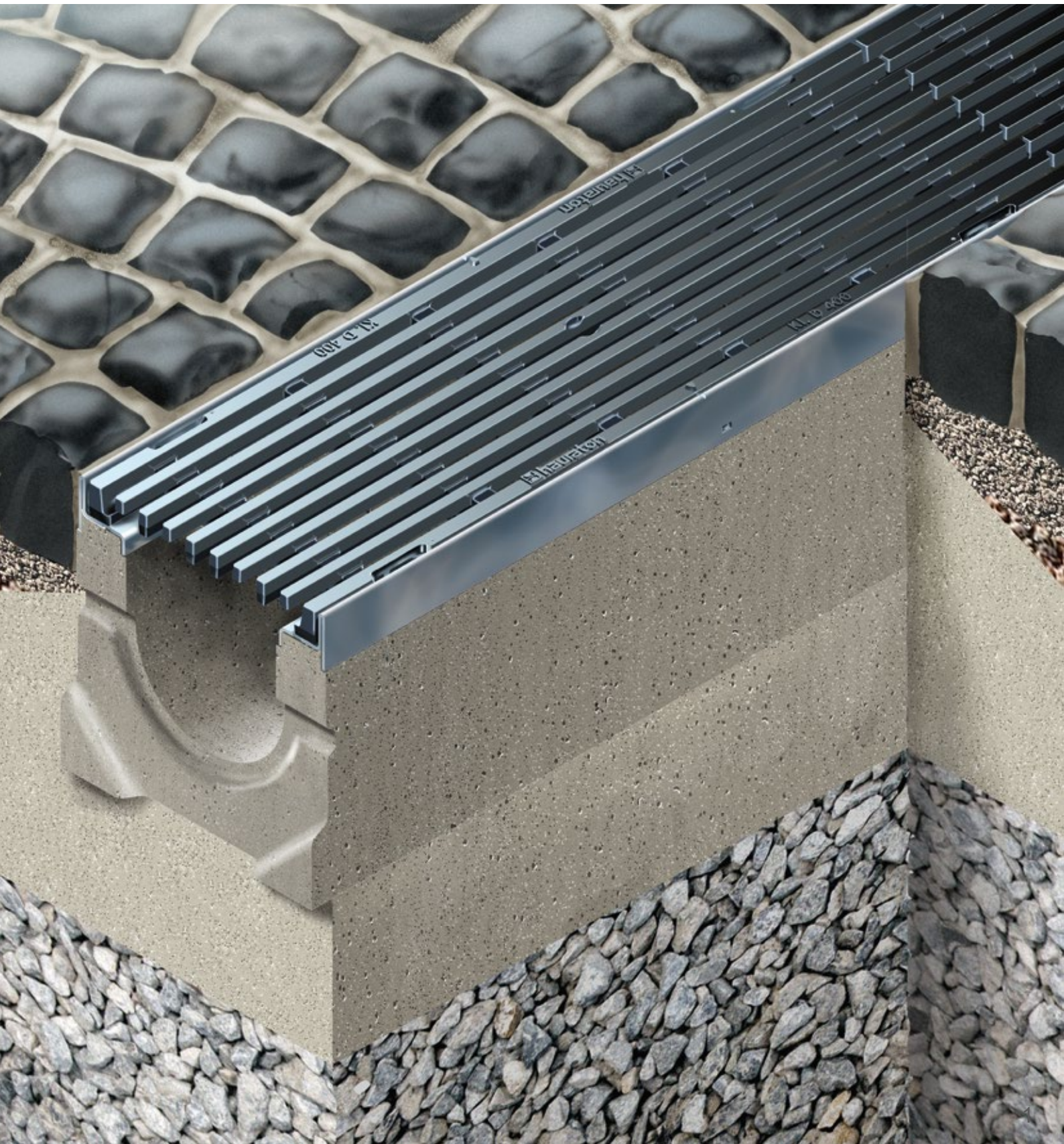



The image shows the exterior of the Museum of the History of Polish Jews in Warsaw, Poland, at night. The building's facade is composed of dark, perforated panels that are illuminated from within, creating a glowing effect. A prominent feature is a large, curved, light-colored panel that curves around the building's corner. The ground in the foreground is paved with cobblestones, and a metal drainage grate is visible. The sky is a deep blue, and other buildings are visible in the background.

**Museum of the History  
of Polish Jews, Warsaw,  
Poland**



# FASERFIX KS

Stable and efficient drainage channels for commercial and public areas.

## 1 Requirements

Drainage channels for commercial and public areas must

- withstand daily traffic by cars and trucks.
- be visually appealing.
- guarantee a simple and safe installation in all surfaces.
- correspond to DIN EN 1433.

## 2 Application areas

- public and commercial areas
- squares and parks
- railway stations
- parking lots

## 3 Solutions

Therefore FASERFIX KS channels offer solutions for any type of application in public and commercial areas:

- stable channels made from fibre-reinforced concrete
- high stability, reduced weight
- boltless locking system SIDE-LOCK with additional possibility to lock with locking handle
- corrosion-resistant galvanised or stainless steel angle housing



Public area, Poland





Public area, Poland



Company parking lots, Great Britain



Railway station in Sopot, Poland

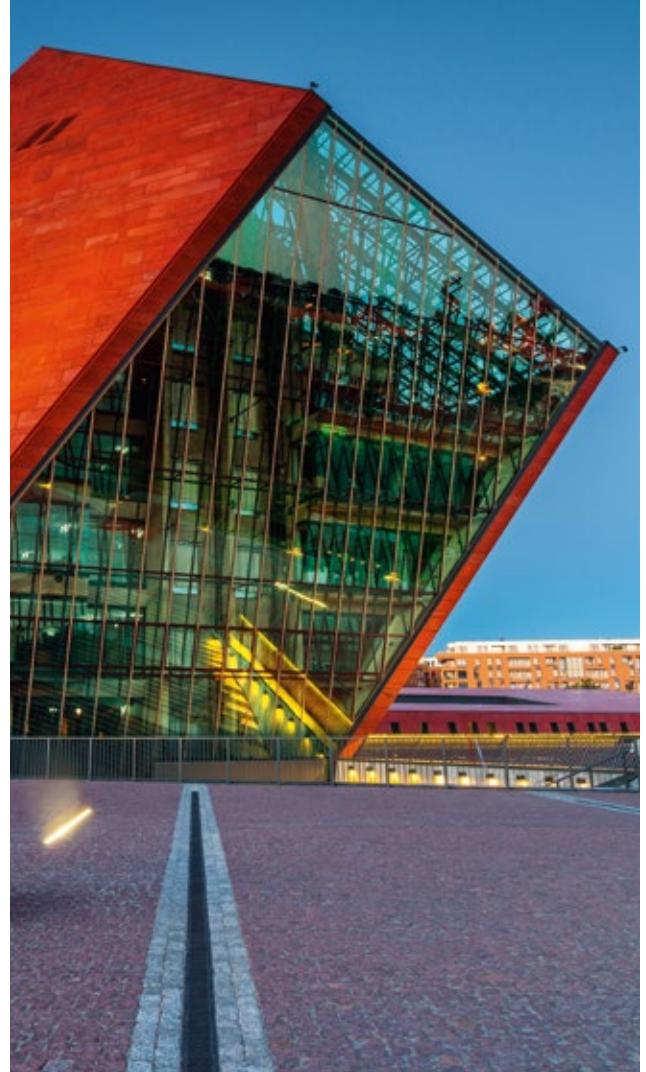

Museum in Gdansk, Poland



Johann Wolfgang Goethe University hospital, Frankfurt, Germany

<b>FASERFIX®SUPER</b>
<b>FASERFIX®KS</b>
<b>FASERFIX®BIG SLG</b>
<b>FASERFIX®BIG BL</b>
<b>RECYFIX®PLUS X</b>
<b>RECYFIX®NC</b>
<b>RECYFIX®MONOTEC</b>
<b>RECYFIX®HICAP®F</b>
<b>FASERFIX®POINT KS</b>
<b>SERVICE CHANNEL</b>

# FASERFIX KS

Stable and efficient drainage channels for commercial and public sectors.

Architecturally sophisticated ICE congress centre in Krakow with a new reliable drainage system.



## Continuous service for over 13 years:

FASERFIX KS channels offer much more than a reliable and efficient drainage: for the optically sophisticated congress centre in Krakow, the cultural capital of Poland, these represent an ideal solution for modern and unique architecture. Not only because of the 36,000 m<sup>2</sup> of the conference space and a capacity of 2,000 people in the auditorium does the ICE meet all requirements for international congress organizations. It also has the highest standards in the field of acoustics and stage technology.

## Why planners of the ICE in Krakow chose HAURATON:

- attractive design to complement the modern architecture (an impressive shape of the building, facade of glass, titanium, zinc and custom-designed ceramic and stone tiles)
- safe and reliable drainage
- flexible system to suit individual requirements
- T-connections for wiring possible
- high hydraulic performance due to large drainage cross-section
- various products that still result in a harmonious appearance





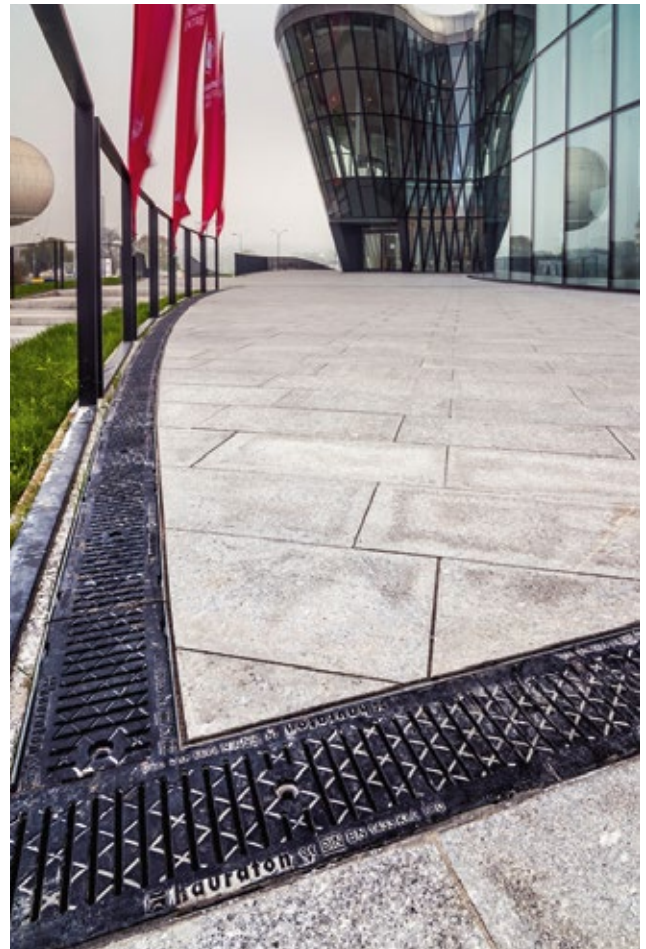
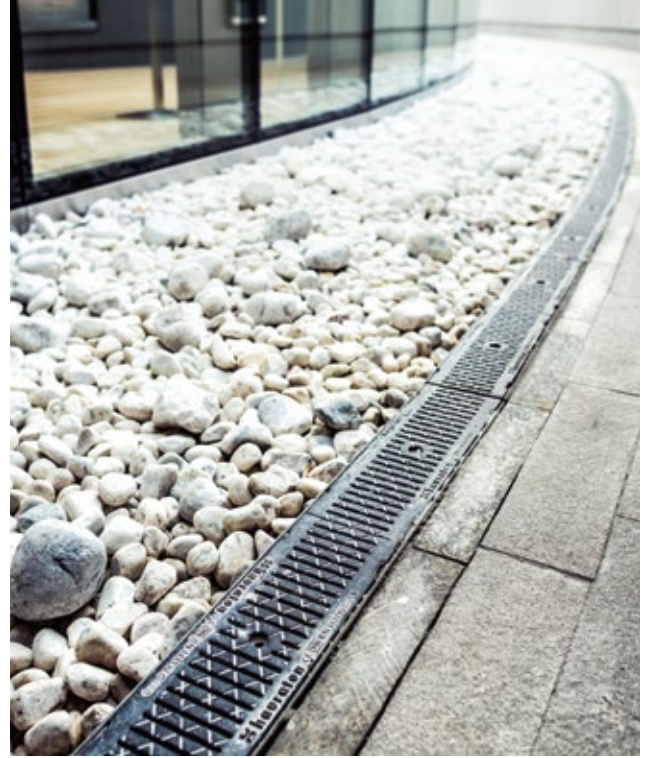

<b>FASERFIX®SUPER</b>
<b>FASERFIX®KS</b>
<b>FASERFIX®BIG SLG</b>
<b>FASERFIX®BIG BL</b>
<b>RECYFIX®PLUS X</b>
<b>RECYFIX®NC</b>
<b>RECYFIX®MONOTEC</b>
<b>RECYFIX®HICAP®F</b>
<b>FASERFIX®POINT KS</b>
<b>SERVICE CHANNEL</b>

# YOUR BENEFITS WITH FASERFIX KS

## HIGH PERFORMANCE ANGLE HOUSING & SIDE-LOCK

- 20 mm x 20 mm angle housing and inlaying grating
- extremely stable connection between steel angle housing and concrete channel body
- 10 fixing points for gratings per metre (incl. 2 times with optional locking handle)
- extra protection against lateral movement
- 90 % time savings in fixing the grating with **SIDE-LOCK** (compared to a conventional fixing)
- replace and insert the grating without any special tool, a screwdriver is enough

= **QUALITY ASSURED & COST SAVINGS**



## NUMEROUS GRATING OPTIONS

- made of ductile iron, composite, galvanised or stainless steel
- narrow slot width for pedestrian areas available

= **DESIGN FLEXIBILITY**



## HIGH STABILITY

- maximum lateral stability through extra thick walls compared to many competitors' products for additional security in extreme situations
- installation for asphalted surface up to class E 600 without concrete stretcher

= **QUALITY- & PERFORMANCE ASSURED**



## HIGH-TECH MATERIAL

- „Made in Germany“
- maximum stability through fibre - reinforced concrete (polypropylene fibres) with low weight
- adheres well to foundation concrete (same coefficient with regard to thermal expansion)
- installation without grating possible
- fire resistance class A1 (not flammable) according to DIN 4102

= **QUALITY- & PERFORMANCE ASSURED**





**IDEAL FOR ...**

applications with high loads up to class F 900, such as traffic areas for commercial and public areas.

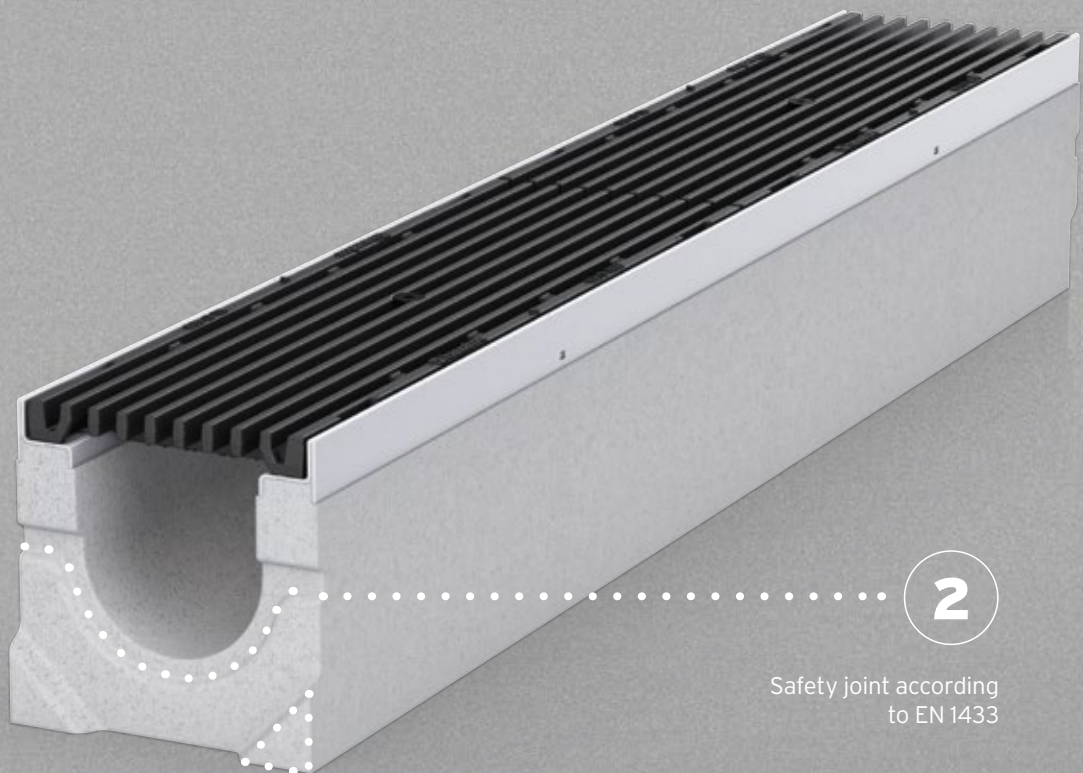

**1**

Tongue and groove connection

**2**

Safety joint according to EN 1433



# FASERFIX KS

Stable and efficient drainage channels for commercial and public sectors.

FASERFIX KS channels meet the requirements of DIN EN 1433 and are suitable for the following load categories:



**Category A 15,**  
Load class 15 kN



**Category B 125,**  
Load class 125 kN



**Category C 250,**  
Load class 250 kN



**Category D 400,**  
Load class 400 kN



**Category E 600,**  
Load class 600 kN



**Category F 900,**  
Load class 900 kN

Numerous grating options,  
for example GUGI-Ductile  
iron mesh gratings

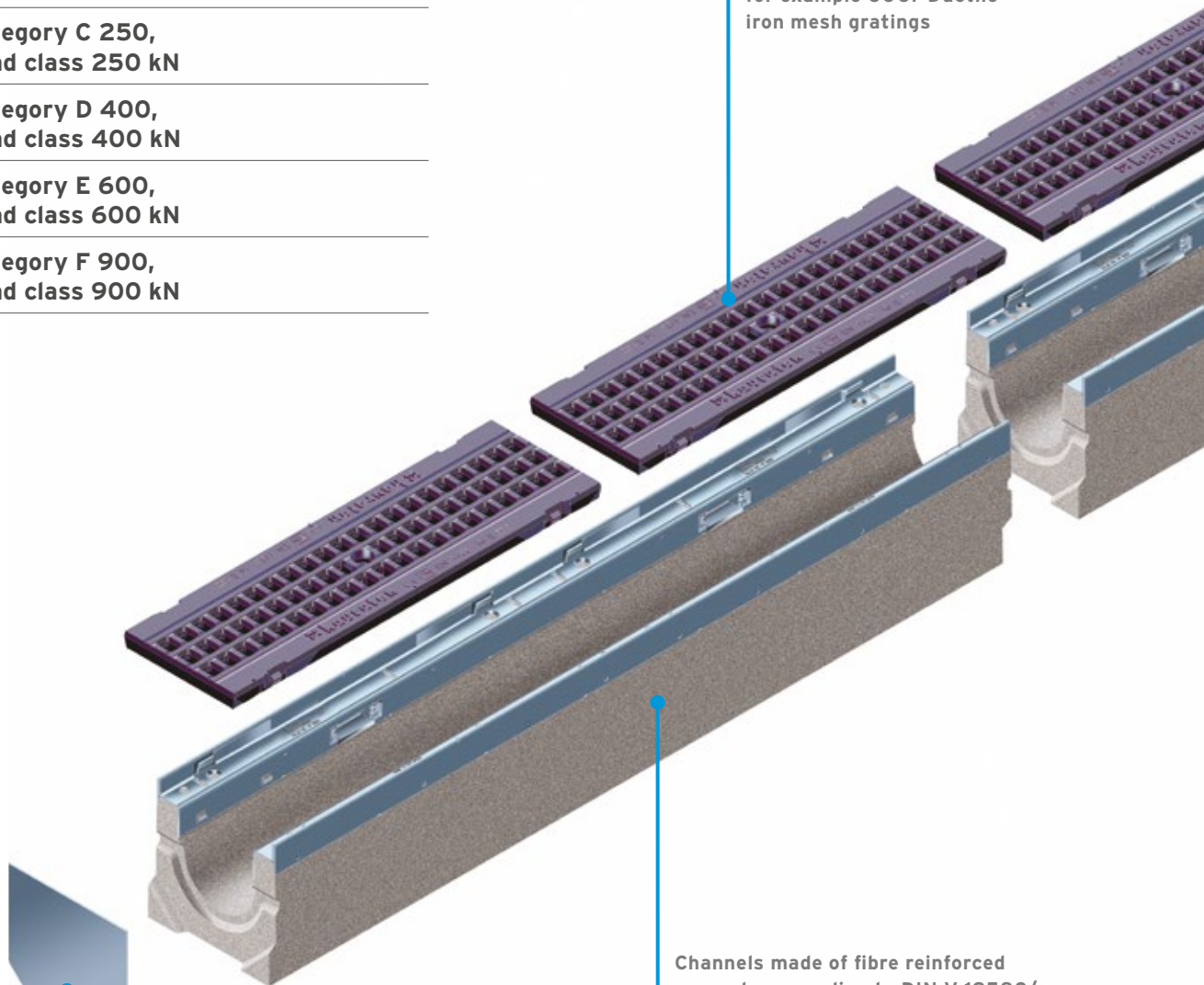

Channels made of fibre reinforced  
concrete, according to DIN V 19580/  
EN 1433, CE-conform with safety  
joint, steel angle housings and  
boltless locking system SIDE-LOCK  
with groove and tongue connection  
for exact installation

End cap without  
outlet



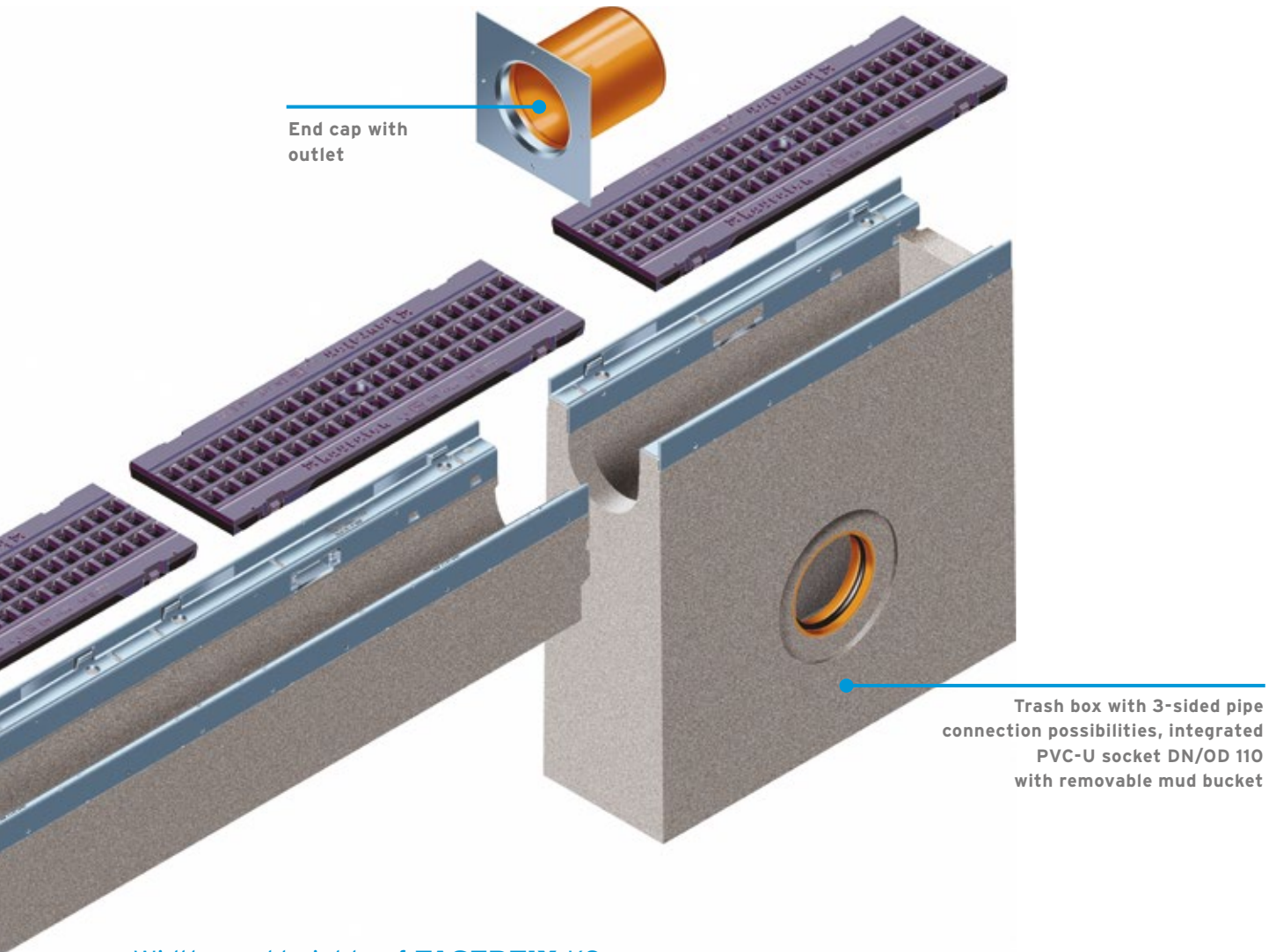

Widths and heights of **FASERFIX KS**:



Nominal sizes	100			150			200			300		
	Width	Height	Inside height	Width	Height	Inside height	Width	Height	Inside height	Width	Height	Inside height
Type 80	160	80	55	-	-	-	-	-	-	-	-	-
Type 100	160	100	75	-	-	-	-	-	-	-	-	-
Type 110	-	-	-	210	110	70	260	110	70	-	-	-
Type 150	-	-	-	210	150	110	260	150	110	-	-	-
Type 200	-	-	-	210	200	160	260	200	160	-	-	-
Type 01	160	160	120	210	220	170	260	275	220	-	-	-
Type 05	160	184	144	-	-	-	-	-	-	-	-	-
Type 010	160	214	174	210	265	215	260	320	265	360	340	270
Type 015	160	244	204	210	290	240	260	345	290	-	-	-
Type 020	160	274	234	210	315	265	260	370	315	-	-	-
available with built-in fall	x			x			x			-		

Width/Height/Inside height (in mm)

- FASERFIX®SUPER
- FASERFIX®KS
- FASERFIX®BIG SLG
- FASERFIX®BIG BL
- RECYFIX®PLUS X
- RECYFIX®NC
- RECYFIX®MONOTEC
- RECYFIX®HICAP®F
- FASERFIX®POINT KS
- SERVICE CHANNEL



# METROPOLIS

Inspired from history - Made for the future





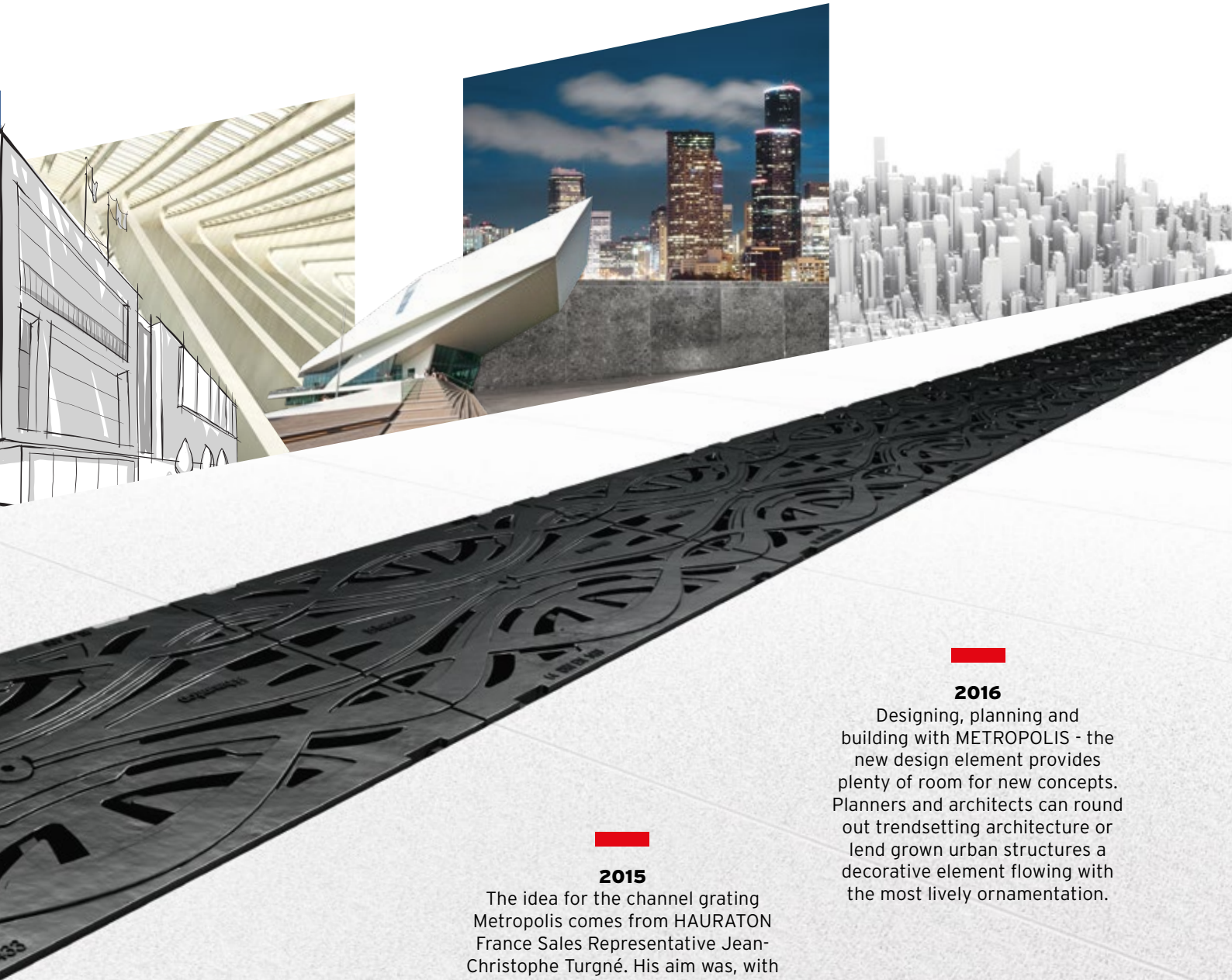

**1927**

The movie 'Metropolis', by Fritz Lang, has influenced various genres since its creation in 1927. With the expressionist representation of a futuristic metropolis, the film producer developed a leitmotif that still inspires artists and designers today.

**2015**

The idea for the channel grating Metropolis comes from HAURATON France Sales Representative Jean-Christophe Turgné. His aim was, with a functional component such as the drainage channel, to set standards with respect to aesthetics and to impart specific construction projects with futuristic, decorative details.

**2016**

Designing, planning and building with METROPOLIS - the new design element provides plenty of room for new concepts. Planners and architects can round out trendsetting architecture or lend grown urban structures a decorative element flowing with the most lively ornamentation.

# The new style of drainage!

Artistically combined, uniquely attractive: coloured **FIBRETEC** gratings.





# FIBRETEC

The art of drainage has many styles. With the coloured **FIBRETEC** gratings, HAURATON creates a completely new scope of design.

The unique channel gratings in the colours Fern, Sand and Stone can be combined with different materials. Thus, new compositions of colours and textures can always be created. As desired, the coloured FIBRETEC gratings can accentuate the colour composition of the surroundings or harmonize as a complete work of art.



Inspiration for the new gratings was the proven black FIBRETEC which has received various awards since its introduction in 2010. One of these awards is the International Design Award Baden-Württemberg Focus Open.



The production of the coloured FIBRETEC gratings in the colours Fern, Sand and Stone is done with coloured granulate. The result are uniformly coloured gratings which are particularly weather and UV-resistant. This was tested and approved in the laboratory according to DIN EN ISO 4892-2 as required by DIN 19580: The gratings were exposed to artificial weathering for a total of 1,600 hours in the form of xenon arc radiation and irrigation.

The subsequent mechanical tests were very successful - optical changes were hardly measurable. However, slight long-term colour changes in the material cannot be ruled out.

**FIBRETEC in Fern**

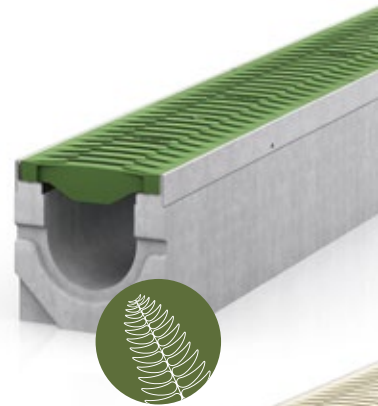

**FIBRETEC in Sand**

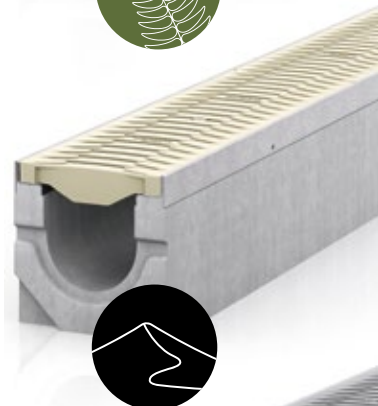

**FIBRETEC in Stone**



**FIBRETEC in Black**



## Grating options **FASERFIX** KS 100

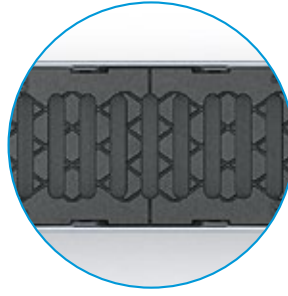

### Ductile iron gratings

Slot width: 100 x 14 mm

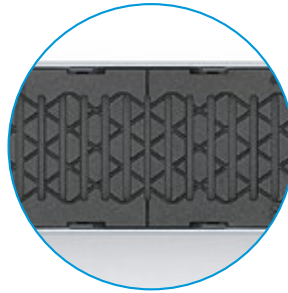

### Ductile iron gratings

Slot width: 100 x 6 mm

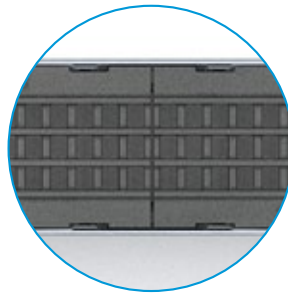

### GUGI-Ductile iron mesh gratings

Mesh width: 15 x 25 mm

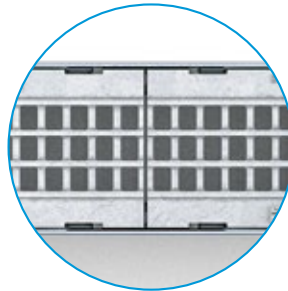

### GUGI-Ductile iron mesh gratings, galvanised

Mesh width: 15 x 25 mm



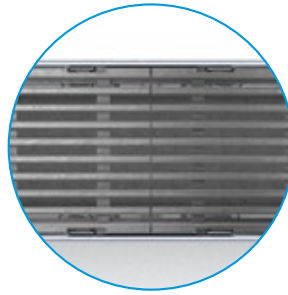

**Longitudinal ductile iron grating, KTL**

Bar distance: 9 mm



**Longitudinal ductile iron grating, galvanised**

Bar distance: 9 mm

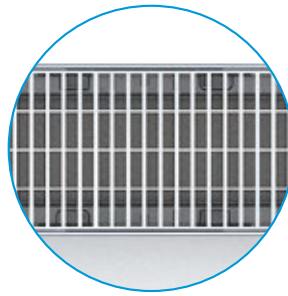

**Mesh grating, galvanised**

Mesh width: 11 x 30 mm

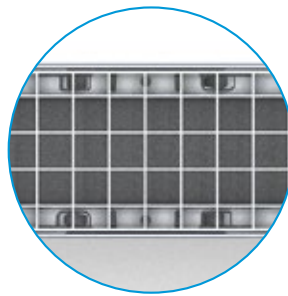

**Mesh grating, galvanised**

Mesh width: 30 x 30 mm

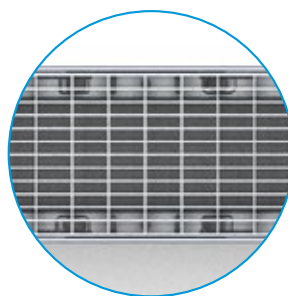

**Mesh grating, galvanised**

Mesh width: 30 x 10 mm

FASERFIX®SUPER
FASERFIX®KS
FASERFIX®BIG SLG
FASERFIX®BIG BL
RECYFIX®PLUS X
RECYFIX®NC
RECYFIX®MONOTEC
RECYFIX®HICAP®F
FASERFIX®POINT KS
SERVICE CHANNEL

## Grating options **FASERFIX** KS 100

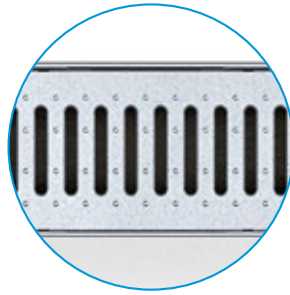

### **Slotted grating, galvanised**

Slot width: 80 x 10 mm

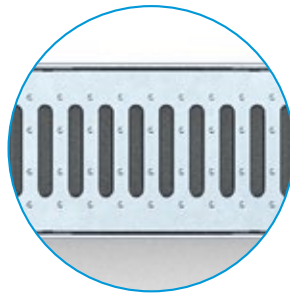

### **Slotted grating, stainless steel**

Slot width: 80 x 10 mm

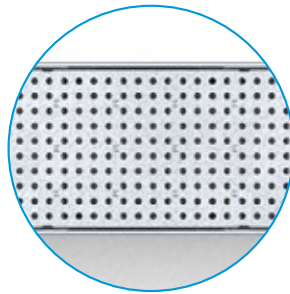

### **Perforated grating, galvanised**

Hole diameter: 6 mm

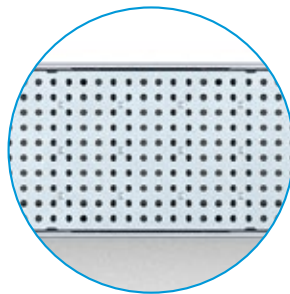

### **Perforated grating, stainless steel**

Hole diameter: 6 mm

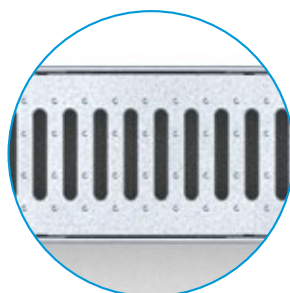

### **Reinforced slotted grating, galvanised**

Slot width: 80 x 10 mm



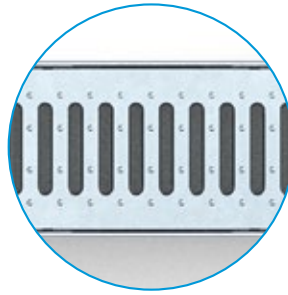

**Reinforced slotted grating, stainless steel**

Slot width: 80 x 10 mm

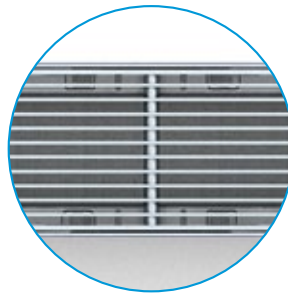

**Longitudinal slot grating, stainless steel**

Bar distance: 10 mm

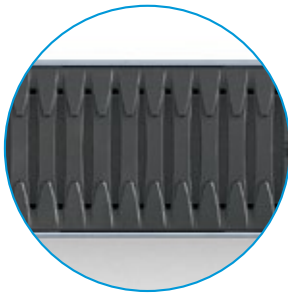

**FIBRETEC design slotted grating, composite material**

Slot width: 9 mm



**GUGI-Ductile iron mesh grating, composite material**

Mesh width: 15 x 25 mm

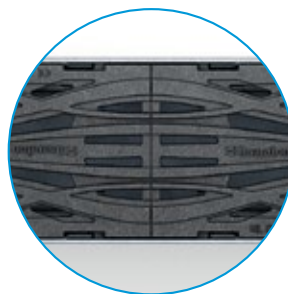

**Ductile iron design grating, METROPOLIS, black, KTL**

FASERFIX®SUPER
FASERFIX®KS
FASERFIX®BIG SLG
FASERFIX®BIG BL
RECYFIX®PLUS X
RECYFIX®NC
RECYFIX®MONOTEC
RECYFIX®HICAP®F
FASERFIX®POINT KS
SERVICE CHANNEL

# FASERFIX®KS 100

## Channels

### FASERFIX®KS 100 up to load class F 900

Type 01

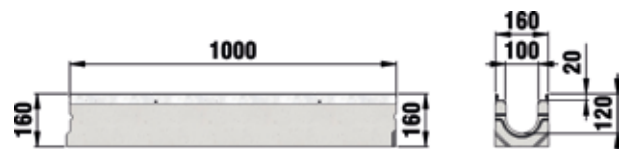

	Length mm	Width mm	Height mm	Internal channel cross-sect. cm <sup>2</sup>	Weight kg	Item-No. galvanised	Item-No. stainless steel
Type 01	1000	160	160	88	33,00	8000	8200
Type 0105	500	160	160	88	16,50	8049	8249
Type 01L with hole DN/OD 110*	1000	160	160	88	32,20	8045	-
Type 05	1000	160	184	113	36,30	8041	-
Type 05L with hole, DN/OD 110*	1000	160	184	113	35,40	8035	-
Type 010	1000	160	214	143	40,20	8042	8242
Type 01005	500	160	214	143	21,50	8050	-
Type 010L with hole DN/OD 110*	1000	160	214	143	39,00	8046	-
Type 015	1000	160	244	173	45,30	8043	8243
Type 015L with hole, DN/OD 110*	1000	160	244	173	45,00	8036	-
Type 020	1000	160	274	206	49,00	8044	8244
Type 020L with hole, DN/OD 110*	1000	160	274	206	48,00	8037	-
Type 80	1000	160	80	34	16,00	1106	1706
Type 100F	1000	160	100	54	19,20	1108	1708
Type 80L, with hole DN/OD 110*	1000	160	80	34	15,30	1137	-
Type 100L, with hole DN/OD 110*	1000	160	100	54	18,60	1138	-

The quality of stainless steel material corresponds to CNS 1.4301 or CNS 1.4307.

\* Position of the opening to the bottom of the channel. 100 mm from the centre of the hole (DN/OD 110) to the end of the channel.



# FASERFIX®KS 100

**FASERFIX®KS 100 with built-in fall 0.6 %, up to load class F 900**

Type 1

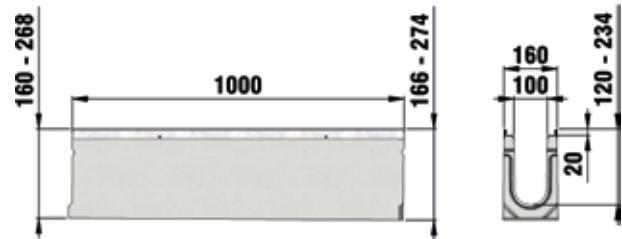

	Length mm	Width mm	Height mm	Internal channel cross-sect. cm <sup>2</sup>	Weight kg	Item-No. galvanised	Item-No. stainless steel
Type 1	1000	160	160 - 166	89	33,00	8001	8201
Type 2	1000	160	166 - 172	95	34,10	8002	8202
Type 3	1000	160	172 - 178	101	34,70	8003	8203
Type 4	1000	160	178 - 184	107	35,60	8004	8204
Type 5	1000	160	184 - 190	113	36,80	8005	8205
Type 6	1000	160	190 - 196	119	37,20	8006	8206
Type 7	1000	160	196 - 202	125	37,90	8007	8207
Type 8	1000	160	202 - 208	131	38,90	8008	8208
Type 9	1000	160	208 - 214	137	39,50	8009	8209
Type 10	1000	160	214 - 220	143	40,00	8010	8210
Type 11	1000	160	220 - 226	149	42,20	8011	8211
Type 12	1000	160	226 - 232	155	43,50	8012	8212
Type 13	1000	160	232 - 238	161	44,00	8013	8213
Type 14	1000	160	238 - 244	167	45,00	8014	8214
Type 15	1000	160	244 - 250	173	45,00	8015	8215
Type 16	1000	160	250 - 256	179	45,50	8016	8216
Type 17	1000	160	256 - 262	185	46,80	8017	8217
Type 18	1000	160	262 - 268	191	47,70	8018	8218
Type 19	1000	160	268 - 274	197	48,00	8019	8219

The quality of stainless steel material corresponds to CNS 1.4301 or CNS 1.4307.

# FASERFIX®KS 100

## Gratings

### FASERFIX®KS 100, class A 15



Slotted grating  
SW 10 mm



Longitudinal slot grating,  
SW 10 mm, stainless steel

	Length mm	Width mm	Height mm	Intake cross-sect. cm <sup>2</sup> /m	Weight kg	Item-No. galvanised	Item-No. stainless steel
Slotted grating SW 10 mm	1000	149	20	278	2,80	8161	8163
Slotted grating SW 10 mm	500	149	20	278	1,30	8162	8164
Longitudinal slot grating, SW 10 mm, stainless steel	1000	149	20	727	5,80	-	8590
Longitudinal slot grating, SW 10 mm, stainless steel	500	149	20	727	2,90	-	8591

The quality of stainless steel material corresponds to CNS 1.4301 or CNS 1.4307.

### FASERFIX®KS 100, class B 125



GUGI mesh grating  
MW 15/25 mm, black,  
made of high-quality  
PA-GF (Polyamide)

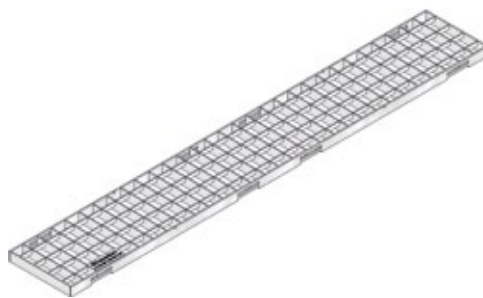

Mesh grating  
MW 30/30 mm, galvanised

	Length mm	Width mm	Height mm	Intake cross-sect. cm <sup>2</sup> /m	Weight kg	Item No.
GUGI mesh grating MW 15/25 mm, black, made of high-quality PA-GF (Polyamide)	500	149	20	426	0,90	8099
Mesh grating MW 30/10 mm, galvanised	1000	149	20	716	4,00	8151
Mesh grating MW 30/10 mm, galvanised	500	149	20	716	2,00	8152
Mesh grating MW 30/30 mm, galvanised	1000	149	20	878	3,00	8077
Mesh grating MW 30/30 mm, galvanised	500	149	20	869	1,50	8078



# FASERFIX®KS 100

## FASERFIX®KS 100, class C 250



Ductile iron grating,  
SW 6 mm, black



FIBRETEC design slotted  
grating in the colour Black,  
SW 9 mm



Mesh grating  
MW 30/10 mm

	Length mm	Width mm	Height mm	Intake cross-sect. cm <sup>2</sup> /m	Weight kg	Item-No. galvanised	Item-No. stainless steel
Ductile iron grating, SW 14 mm, black	500	149	20	462	3,40	28064	-
Ductile iron grating, SW 14 mm, KTL-coated	500	149	20	462	3,30	8864	-
Ductile iron grating, SW 6 mm, black	500	149	20	280	3,60	28068	-
Ductile iron grating, SW 6 mm, KTL-coated	500	149	20	280	3,60	8868	-
Ductile iron grating, SW 100/6 mm, galvanised	500	149	20	280	3,60	29868	-
Ductile iron grating, SW 100/14 mm, galvanised	500	149	20	462	3,40	29864	-
Longitudinal ductile iron grating SW 9 mm, galvanised	500	149	20	528	3,70	8876	-
Longitudinal ductile iron grating SW 9 mm, KTL-coated	500	149	20	528	3,70	8875	-
FIBRETEC design slotted grating in the colour Black, SW 9 mm	500	149	20	372	1,10	8098	-
FIBRETEC design slotted grating in the colour Sand, SW 9 mm	500	149	20	372	1,10	8100	-
FIBRETEC design slotted grating in the colour Fern, SW 9 mm	500	149	20	372	1,10	8102	-
FIBRETEC design slotted grating in the colour Stone, SW 9 mm	500	149	20	372	1,10	8101	-
Mesh grating MW 30/10 mm	1000	149	20	716	5,00	8154	28577
Mesh grating MW 30/10 mm	500	149	20	716	2,60	8155	28578
Mesh grating MW 30/30 mm, galvanised	1000	149	20	828	4,40	28073	-
Mesh grating MW 30/30 mm, galvanised	500	149	20	819	2,20	28074	-
Reinforced slotted grating, SW 10 mm	1000	149	20	281	5,30	28167	28169
Reinforced slott grating, SW 10 mm	500	149	20	281	2,60	28168	28170
Perforated grating diam. 6 mm	1000	149	20	191	5,30	28171	28177
Perforated grating diam. 6 mm	500	149	20	191	2,60	28172	28178

The quality of stainless steel material corresponds to CNS 1.4301 or CNS 1.4307.

# FASERFIX®KS 100

## Gratings

### FASERFIX®KS 100, class D 400\*



Ductile iron design grating,  
METROPOLIS, black,  
KTL-coated



Ductile iron longitudinal grating,  
SW 9 mm, KTL-coated

	Length mm	Width mm	Height mm	Intake cross-sect. cm <sup>2</sup> /m	Weight kg	Item No.
Ductile iron grating, SW 14 mm, black	500	149	20	462	3,70	28063
Ductile iron grating, SW 14 mm, KTL-coated	500	149	20	462	3,70	8863
Ductile iron design grating, METROPOLIS, black, KTL-coated	500	149	20	165	5,10	8871
Ductile iron longitudinal grating, SW 9 mm, KTL-coated	500	149	20	528	4,20	8869
Ductile iron longitudinal grating, SW 9 mm, galvanised	500	149	20	528	4,20	8870
Ductile iron grating, SW 100/14 mm, galvanised	500	149	20	462	3,70	29863

\* Not for use across the carriageway of highways or motorways in moving traffic.



# FASERFIX®KS 100

## FASERFIX®KS 100, class E 600



Ductile iron grating,  
SW 6 mm, black



GUGI-Ductile iron mesh grating  
MW 15/25 mm, black

	Length mm	Width mm	Height mm	Intake cross-sect. cm <sup>2</sup> /m	Weight kg	Item-No. galvanised	Item-No. stainless steel
Ductile iron grating, SW 14 mm, black	500	149	20	462	4,10	28062	-
Ductile iron grating, SW 6 mm, black	500	149	20	280	4,10	28066	-
Ductile iron grating, SW 14 mm, KTL-coated	500	149	20	462	4,20	8862	-
Ductile iron grating, SW 6 mm, KTL-coated	500	149	20	280	4,00	8866	-
GUGI-Ductile iron mesh grating, MW 15/25 mm, black	500	149	20	426	4,50	28079	-
GUGI-Ductile iron mesh grating, MW 15/25 mm, KTL-coated	500	149	20	426	4,50	8879	-
GUGI-Ductile iron mesh grating, MW 15/25 mm, galvanised	500	149	20	426	4,60	28080	-
Mesh grating MW 11/30 mm	1000	149	20	695	11,00	28071	28571
Mesh grating MW 11/30 mm	500	149	20	695	5,90	28072	28572

The quality of stainless steel material corresponds to CNS 1.4301 or CNS 1.4307.  
Solid ductile iron covers (closed) can be found in the range SERVICE CHANNELS.

## FASERFIX®KS 100, class F 900



Ductile iron grating  
100/14 mm, black

	Length mm	Width mm	Height mm	Intake cross-sect. cm <sup>2</sup> /m	Weight kg	Item No.
Ductile iron grating 100/14 mm, black	500	149	20	462	4,50	28061

# FASERFIX®KS 100

## Accessories

### Trash boxes

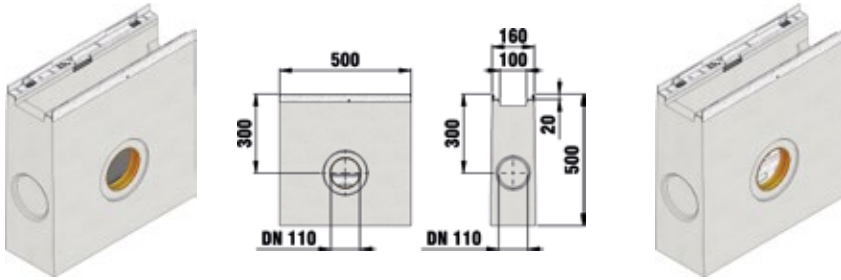

Trash box with composite bucket

Trash box with galvanised bucket

	Length mm	Width mm	Height mm	Weight kg	Item-No. galvanised	Item-No. stainless steel
Trash box with composite bucket	500	160	500	47,70	8052	8252
Trash box with galvanised bucket	500	160	500	50,00	8053	-

The quality of stainless steel material corresponds to CNS 1.4301 or CNS 1.4307.



# FASERFIX®KS 100

## End caps



End cap closed,  
type 01



End cap closed,  
type 010

	Length mm	Width mm	Height mm	Weight kg	Item-No. galvanised	Item-No. stainless steel
End cap closed, type 01	-	160	160	0,40	8081	8181
End cap closed, type 010	-	160	214	0,50	8082	8182
End cap closed, type 020	-	160	274	0,60	8083	8183
End cap closed, type 80	-	160	80	0,20	1181	1681
End cap closed, type 100F	-	160	100	0,20	1183	1683
End cap with horizontal PVC-U pipe outlet DN/OD 110, type 010	-	160	214	0,60	8087	8186
End cap with horizontal PVC-U pipe outlet DN/OD 110, type 020	-	160	274	0,70	8089	8187

The quality of stainless steel material corresponds to CNS 1.4301 or CNS 1.4307.

# FASERFIX®KS 100

## Accessories

### Further accessories



Foul air trap, horizontal, with rubber sealing, black



Foul air trap DN/OD 110, outside



Mud bucket vertical made of modified composite for outlet DN/OD 110, black



Installation aid NW 100 (2 pieces required) - due to security reasons no return can be made

	Length mm	Width mm	Height mm	Weight kg	Item No.
Foul air trap, horizontal, with rubber sealing, black	-	-	-	0,10	966
Foul air trap DN/OD 110, with hole	-	-	103	0,20	964
Foul air trap DN/OD 110, outside	-	-	-	0,40	961
PVC-U pipe outlet, DN/OD 110	-	-	-	0,20	903
PVC mud bucket for trash box, 50 cm	420	85	152	0,20	940
Mud bucket vertical made of modified composite for outlet DN/OD 110, black	100	100	85	0,00	40293
Universal sealant/adhesive Siga-Meltell® 220 black**	-	-	-	1,00	19051
Tubular pistol for universal sealant/adhesive Siga-Meltell® 220 black**	-	-	-	1,30	6891
Locking handle for SUPER KS 100 ductile iron grating	28	117	35	0,10	98210
Installation aid NW 100 (2 pieces required) - due to security reasons no return can be made	-	-	-	1,60	705

\*\* Consumption for channel type 020: approx. 65 ml per joint.

# FASERFIX®KS 100

## Factory-made services



Cutting to length of NW 100



Mitre cuts NW 100  
(price per cut, two cuts necessary)



Cutting for gradient  
for all nominal widths



Drilling of connecting holes  
DN/OD 75



Factory-made insertion  
of PVC-U union connectors  
DN/OD 110 (incl. drilling)



Fixing-system EP, empty pipe  
in the channel bottom,  
(2 pieces per metre)

	Length mm	Width mm	Height mm	Weight kg	Item No.
Cutting to length of NW 100	-	-	-	-	990
Mitre cuts NW 100 (price per cut, two cuts necessary)	-	-	-	-	995
Cutting for gradient for all nominal widths	-	-	-	-	890
Drilling of connecting holes DN/OD 75	-	-	-	-	971
Drilling of connecting holes DN/OD 110	-	-	-	-	972
Factory-made insertion of modified PP union connectors DN/OD 75 (incl. drilling)	-	-	-	-	981
Factory-made insertion of PVC-U union connectors DN/OD 110 (incl. drilling)	-	-	-	-	982
Fixing-system EP, empty pipe in the channel bottom, (2 pieces per metre)	-	-	-	-	703
steel bars for fixing system EP (2 pieces per metre)	-	-	-	-	704



## Grating options

### FASERFIX KS 150



#### Ductile iron gratings

Slot width: 132 x 20 mm

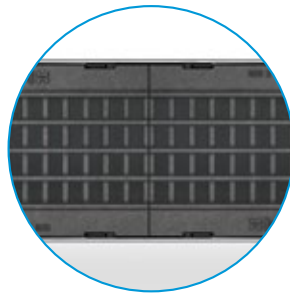
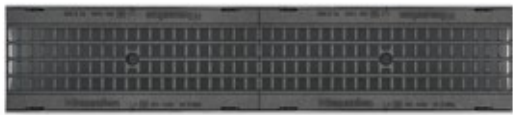

#### GUGI-Ductile iron mesh gratings

Mesh width: 15 x 25 mm

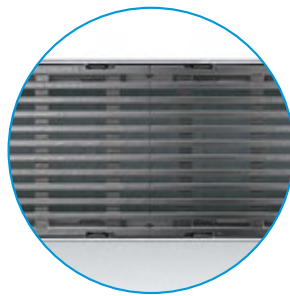

#### Longitudinal ductile iron grating, KTL

Bar distance: 9 mm

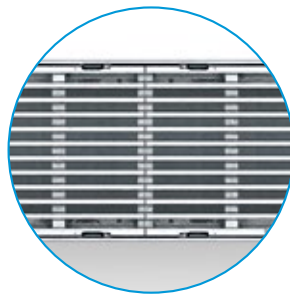

#### Longitudinal ductile iron grating, galvanised

Bar distance: 9 mm

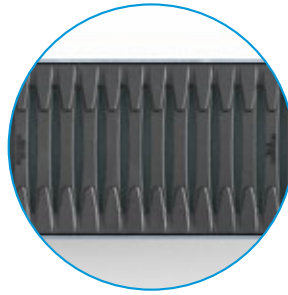

**FIBRETEC design  
slotted grating,  
black**

Slot width: 9 mm

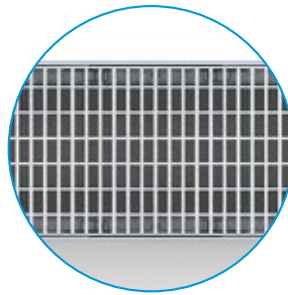

**Mesh grating,  
galvanised**

Mesh width: 11 x 30 mm

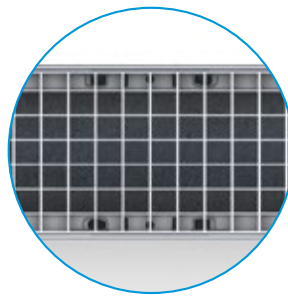

**Mesh grating,  
galvanised**

Mesh width: 30 x 30 mm

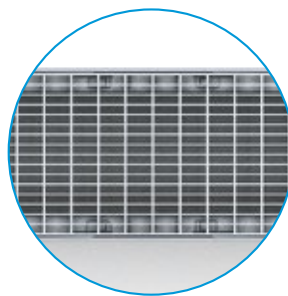

**Mesh grating,  
galvanised**

Mesh width: 30 x 10 mm

FASERFIX®SUPER

FASERFIX®KS

FASERFIX®BIG SLG

FASERFIX®BIG BL

RECYFIX®PLUS X

RECYFIX®NC

RECYFIX®MONOTEC

RECYFIX®HICAP®F

FASERFIX®POINT KS

SERVICE CHANNEL

Grating options  
**FASERFIX** KS 150

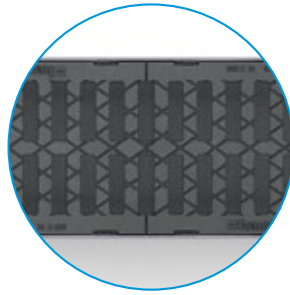

**Ductile iron gratings**

Slot width: 2 x 85 x 20 mm



# FASERFIX®KS 150

## Channels

### FASERFIX®KS 150 up to class F 900

Type 01

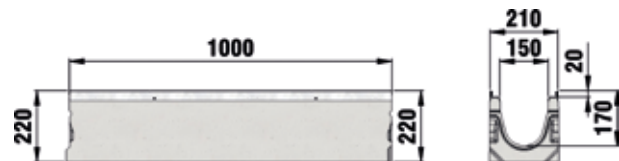

	Length mm	Width mm	Height mm	Internal channel cross-sect. cm <sup>2</sup>	Weight kg	Item-No. galvanised	Item-No. stainless steel
Type 01	1000	210	220	185	54,50	11000	11500
Type 01L, with hole DN/OD 160*	1000	210	220	185	54,00	11035	-
Type 0105	500	210	220	185	27,00	11049	-
Type 010	1000	210	265	245	60,20	11042	11542
Type 010L with hole, DN/OD 160*	1000	210	265	245	61,00	11036	-
Type 015	1000	210	290	282	66,00	11043	-
Type 020	1000	210	315	312	69,60	11044	11544
Type 020L, with opening DN/OD 160*	1000	210	315	312	68,00	11037	-
Type 110**	1000	210	110	74	28,30	2121	-
Type 150**	1000	210	150	134	33,60	2122	-
Type 200**	1000	210	200	208	40,00	2123	-

The quality of stainless steel material corresponds to CNS 1.4301 or CNS 1.4307.

\* Position of the opening to the bottom of the channel. 130 mm from the centre of the hole (DN/OD 160) to the end of the channel.

\*\* Suitable for the use in parking areas.

# FASERFIX®KS 150

## FASERFIX®KS 150 with built-in fall 0.5 %, up to load class F 900

Type 1

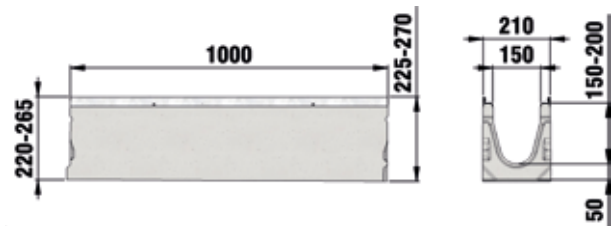

	Length mm	Width mm	Height mm	Internal channel cross-sect. cm <sup>2</sup>	Weight kg	Item-No. galvanised	Item-No. stainless steel
Type 1	1000	210	220 - 225	186	54,60	11001	11501
Type 2	1000	210	225 - 230	196	55,00	11002	11502
Type 3	1000	210	230 - 235	203	55,90	11003	11503
Type 4	1000	210	235 - 240	211	56,70	11004	11504
Type 5	1000	210	240 - 245	218	57,20	11005	11505
Type 6	1000	210	245 - 250	226	58,00	11006	11506
Type 7	1000	210	250 - 255	233	58,40	11007	11507
Type 8	1000	210	255 - 260	241	59,00	11008	11508
Type 9	1000	210	260 - 265	248	59,80	11009	11509

The quality of stainless steel material corresponds to CNS 1.4301 or CNS 1.4307.

# FASERFIX®KS 150

## Gratings

### FASERFIX®KS 150, class B 125



FIBRETEC design slotted grating,  
SW 9 mm, black

	Length mm	Width mm	Height mm	Intake cross-sect. cm <sup>2</sup> /m	Weight kg	Item No.
FIBRETEC design slotted grating, SW 9 mm, black	500	199	20	500	2,00	47170

### FASERFIX®KS 150, class C 250



Ductile iron grating,  
SW 20 mm, black

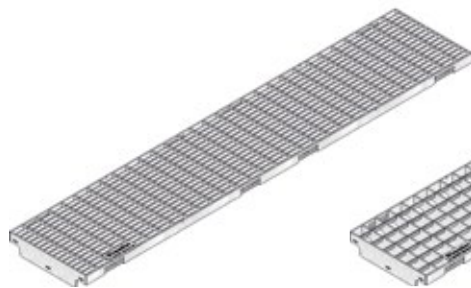

Mesh grating  
MW 30/10 mm



Mesh grating  
MW 30/30 mm, galvanised

	Length mm	Width mm	Height mm	Intake cross-sect. cm <sup>2</sup> /m	Weight kg	Item-No. galvanised	Item-No. stainless steel
Ductile iron grating, SW 20 mm, black	500	199	20	631	4,50	11064	-
Ductile iron grating, SW 20 mm, KTL-coated	500	199	20	631	5,30	11264	-
Ductile iron grating, SW 132/20 mm, galvanised	500	199	20	631	4,50	11364	-
Mesh grating MW 30/10 mm	1000	199	20	1105	7,20	11075	11575
Mesh grating MW 30/10 mm	500	199	20	1105	3,70	11076	11576
Mesh grating MW 30/30 mm, galvanised	1000	199	20	1240	5,90	11073	-
Mesh grating MW 30/30 mm, galvanised	500	199	20	1240	3,40	11074	-

The quality of stainless steel material corresponds to CNS 1.4301 or CNS 1.4307.



# FASERFIX®KS 150

## FASERFIX®KS 150, class D 400\*



Ductile iron grating,  
SW 18 mm, black



Longitudinal ductile iron grating,  
SW 9 mm, KTL-coated

	Length mm	Width mm	Height mm	Intake cross-sect. cm <sup>2</sup> /m	Weight kg	Item No.
Ductile iron grating, SW 18 mm, black	500	199	20	553	5,30	11463
Ductile iron grating, SW 18 mm, KTL-coated	500	199	20	553	5,30	11563
Longitudinal ductile iron grating, SW 9 mm, KTL-coated	500	199	20	740	6,90	11269
Longitudinal ductile iron grating, SW 9 mm, galvanised	500	199	20	740	6,90	11369

\* Not for use across the carriageway of highways or motorways in moving traffic.

## FASERFIX®KS 150, class E 600



Ductile iron grating  
SW 9 mm, black



GUGI-Ductile iron mesh grating  
MW 15/25 mm, black



Mesh grating  
MW 11/30 mm

	Length mm	Width mm	Height mm	Intake cross-sect. cm <sup>2</sup> /m	Weight kg	Item-No. galvanised	Item-No. stainless steel
Ductile iron grating, SW 9 mm, black	500	199	20	557	6,70	11066	-
Ductile iron grating, SW 9 mm, KTL-coated	500	199	20	557	6,70	11266	-
GUGI-Ductile iron mesh grating, MW 15/25 mm, black	500	199	20	716	7,40	11068	-
GUGI-Ductile iron mesh grating, MW 15/25 mm, KTL-coated	500	199	20	716	7,80	11268	-
Mesh grating MW 11/30 mm	1000	199	20	981	18,80	11071	11571
Mesh grating MW 11/30 mm	500	199	20	981	9,70	11072	-

The quality of stainless steel material corresponds to CNS 1.4301 or CNS 1.4307.  
Solid ductile iron covers (closed) can be found in the range SERVICE CHANNELS.

# FASERFIX®KS 150

## Gratings

### FASERFIX®KS 150, class F 900



Ductile iron grating,  
SW 20 mm, black



Ductile iron grating,  
SW 20 mm, KTL-coated

	Length mm	Width mm	Height mm	Intake cross-sect. cm <sup>2</sup> /m	Weight kg	Item No.
Ductile iron grating, SW 20 mm, black	500	199	20	626	7,80	11061
Ductile iron grating, SW 20 mm, KTL-coated	500	199	20	626	7,80	11261

# FASERFIX®KS 150

## Accessories

### Trash boxes

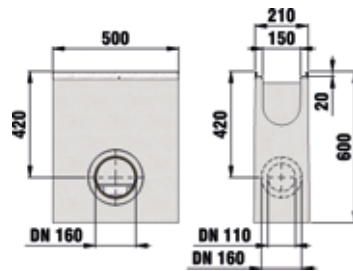

Trash box with galvanised bucket

	Length mm	Width mm	Height mm	Weight kg	Item-No. galvanised	Item-No. stainless steel
Trash box with galvanised bucket	500	210	600	65,30	11052	11552

The quality of stainless steel material corresponds to CNS 1.4301 or CNS 1.4307.

### End caps



End cap closed, type 010

End cap with horizontal PVC-U pipe outlet DN/OD 160, type 020

	Length mm	Width mm	Height mm	Weight kg	Item-No. galvanised	Item-No. stainless steel
End cap closed, type 01	-	210	220	0,70	11081	11581
End cap closed, type 010	-	210	265	0,80	11082	11582
End cap closed, type 020	-	210	315	1,00	11083	11583
End cap closed, type 110	-	210	110	0,40	2181	2681
End cap closed, type 150	-	210	150	0,50	2182	-
End cap closed, type 200	-	210	200	0,60	2183	2683
End cap with horizontal PVC-U pipe outlet DN/OD 160, type 01 - 010	-	210	265	1,00	11087	11587
End cap with horizontal PVC-U pipe outlet DN/OD 160, type 020	-	210	315	1,10	11088	11588

The quality of stainless steel material corresponds to CNS 1.4301 or CNS 1.4307.



# FASERFIX®KS 150

## Accessories

### Further accessories



Foul air trap  
DN/OD 160

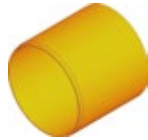

PVC-U pipe connection element  
DN/OD 160



Mud bucket for outlet  
DN/OD 160

	Length mm	Width mm	Height mm	Weight kg	Item No.
Foul air trap DN/OD 160	584	160	439	2,00	960
PVC-U pipe connection element DN/OD 160	-	-	-	0,50	906
Mud bucket for outlet DN/OD 160	-	-	180	0,80	2191
Locking handle for all ductile iron gratings	-	-	-	0,10	98260
Universal sealant/adhesive Siga-Meltell® 220 black**	-	-	-	1,00	19051
Tubular pistol for universal sealant/adhesive Siga-Meltell® 220 black**	-	-	-	1,30	6891
Installation aid NW 150 (2 pieces required) - due to security reasons no return can be made	-	-	-	2,10	136018

**\*\* Consumption for channel type 020: approx. 94 ml per joint.**

# FASERFIX®KS 150

## Factory-made services



Cutting to length of NW 150



Cutting for gradient for all nominal widths



Fixing-system EP, empty pipe in the channel bottom, (2 pieces per metre)

	Length mm	Width mm	Height mm	Weight kg	Item No.
Cutting to length of NW 150	-	-	-	-	991
Mitre cuts NW 150 (price per cut, two cuts necessary)	-	-	-	-	996
Cutting for gradient for all nominal widths	-	-	-	-	890
Drilling of connecting holes DN/OD 160	-	-	-	-	973
Factory-made insertion of PVC-U union connectors DN/OD 160 (incl. drilling)	-	-	-	-	983
Fixing-system EP, empty pipe in the channel bottom, (2 pieces per metre)	-	-	-	-	703
steel bars for fixing system EP (2 pieces per metre)	-	-	-	-	704

Grating options  
**FASERFIX KS 200**

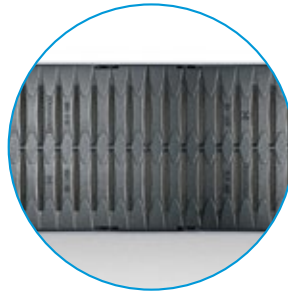

**G-TEC Ductile iron grating, KTL**

Slot width: 2 x 85 x 9 mm



**GUGI-Ductile iron mesh gratings**

Mesh width: 15 x 25 mm

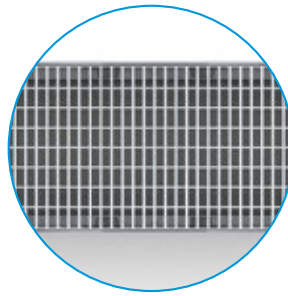
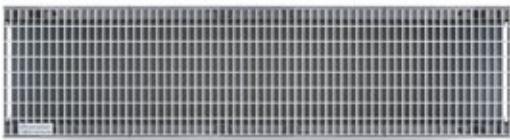

**Mesh grating, galvanised**

Mesh width: 11 x 30 mm



**Longitudinal ductile iron grating, galvanised**

Bar distance: 9 mm

<b>FASERFIX<sup>®</sup>SUPER</b>
<b>FASERFIX<sup>®</sup>KS</b>
<b>FASERFIX<sup>®</sup>BIG SLG</b>
<b>FASERFIX<sup>®</sup>BIG BL</b>
<b>RECYFIX<sup>®</sup>PLUS X</b>
<b>RECYFIX<sup>®</sup>NC</b>
<b>RECYFIX<sup>®</sup>MONOTEC</b>
<b>RECYFIX<sup>®</sup>HICAP<sup>®</sup>F</b>
<b>FASERFIX<sup>®</sup>POINT KS</b>
<b>SERVICE CHANNEL</b>



## Grating options

### FASERFIX KS 200



#### Ductile iron longitudinal grating, KTL

Bar distance: 9 mm

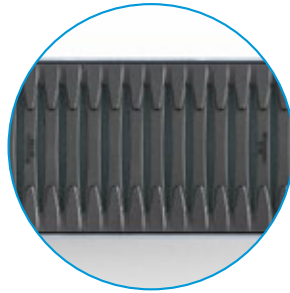

#### FIBRETEC design slotted grating, composite material

Slot width: 9 mm

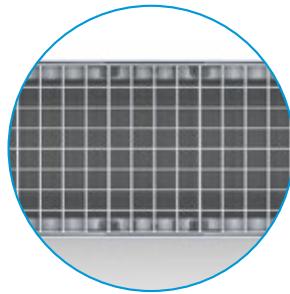
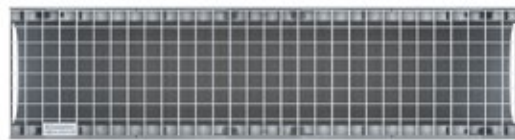

#### Mesh grating, galvanised

Mesh width: 30 x 30 mm

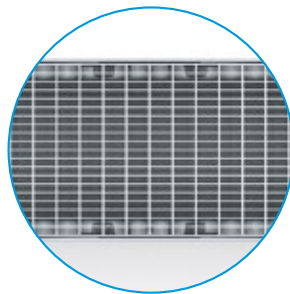

#### Mesh grating, galvanised

Mesh width: 30 x 10 mm

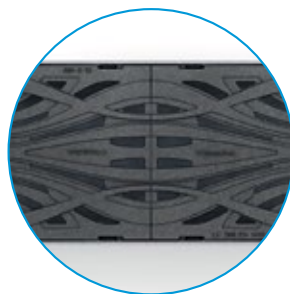

#### Ductile iron design grating METROPOLIS

# FASERFIX®KS 200

## Channels

### FASERFIX®KS 200 up to load class F 900

Type 01

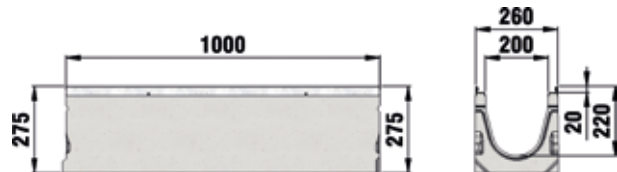

	Length mm	Width mm	Height mm	Internal channel cross-sect. cm <sup>2</sup>	Weight kg	Item-No. galvanised	Item-No. stainless steel
Type 01	1000	260	275	319	79,00	12000	12500
Type 0105	500	260	275	319	39,00	12049	12549
Type 01L with hole DN/OD 160*	1000	260	275	319	79,00	12035	-
Type 010	1000	260	320	409	84,90	12042	12542
Type 010L with hole, DN/OD 160*	1000	260	320	409	88,00	12036	-
Type 015	1000	260	345	462.38	89,00	12043	-
Type 020	1000	260	370	509	91,60	12044	12544
Type 020L with hole, DN/OD 160*	1000	260	370	509	95,00	12037	-
Type 110**	1000	260	110	89	32,50	3121	-
Type 150**	1000	260	150	148	38,50	3122	-
Type 200**	1000	260	200	246	45,50	3123	-

The quality of stainless steel material corresponds to CNS 1.4301 or CNS 1.4307.

\* Position of the opening to the bottom of the channel. 130 mm from the centre of the hole (DN/OD 160) to the end of the channel.

\*\* Suitable for the use in parking areas.

# FASERFIX®KS 200

**FASERFIX®KS 200 with built-in fall 0.5 %, up to load class F 900**

Type 2

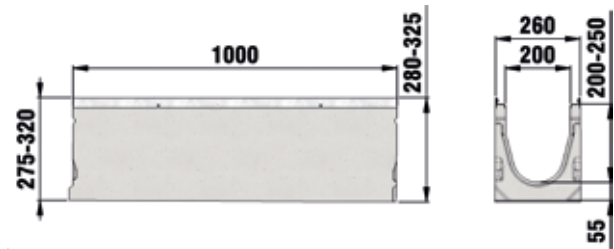

	Length mm	Width mm	Height mm	Internal channel cross-sect. cm <sup>2</sup>	Weight kg	Item-No. galvanised	Item-No. stainless steel
Type 1	1000	260	275 - 280	324	79,00	12001	12501
Type 2	1000	260	280 - 285	334	79,70	12002	12502
Type 3	1000	260	285 - 290	344	80,50	12003	12503
Type 4	1000	260	290 - 295	354	80,80	12004	12504
Type 5	1000	260	295 - 300	364	81,90	12005	12505
Type 6	1000	260	300 - 305	374	82,40	12006	12506
Type 7	1000	260	305 - 310	384	82,50	12007	12507
Type 8	1000	260	310 - 315	394	83,50	12008	12508
Type 9	1000	260	315 - 320	404	86,00	12009	12509

The quality of stainless steel material corresponds to CNS 1.4301 or CNS 1.4307.



# FASERFIX®KS 200

## Gratings

### FASERFIX®KS 200, class B 125



FIBRETEC design slotted grating in the colour Black, SW 9 mm

	Length mm	Width mm	Height mm	Intake cross-sect. cm <sup>2</sup> /m	Weight kg	Item No.
FIBRETEC design slotted grating in the colour Black, SW 9 mm	500	249	20	656	2,11	12098

### FASERFIX®KS 200, class C 250



Ductile iron grating,  
SW 20 mm, black



Ductile iron grating,  
SW 20 mm, KTL-coated



Mesh grating  
MW 30/10 mm

	Length mm	Width mm	Height mm	Intake cross-sect. cm <sup>2</sup> /m	Weight kg	Item-No. galvanised	Item-No. stainless steel
Ductile iron grating SW 20 mm, black	500	249	20	823	5,60	12064	-
Ductile iron grating, SW 20 mm, KTL-coated	500	249	20	823	5,80	12264	-
Mesh grating MW 30/10 mm	1000	249	20	1500	10,80	12075	12575
Mesh grating MW 30/10 mm	500	249	20	1500	5,50	12076	12576
Mesh grating MW 30/30 mm	1000	249	20	1681	9,20	12073	12573
Mesh grating MW 30/30 mm	500	249	20	1681	4,60	12074	12574

The quality of stainless steel material corresponds to CNS 1.4301 or CNS 1.4307.  
Solid ductile iron covers (closed) can be found in the range SERVICE CHANNELS.

# FASERFIX®KS 200

## FASERFIX®KS 200, class D 400\*



G-TEC Ductile iron grating, SW 9 mm, KTL-coated



Ductile iron longitudinal grating SW 9 mm, KTL-coated

	Length mm	Width mm	Height mm	Intake cross-sect. cm <sup>2</sup> /m	Weight kg	Item No.
Ductile iron grating SW 18 mm, black	500	249	20	731	6,80	12463
G-TEC Ductile iron grating, SW 9 mm, KTL-coated	500	249	20	595	8,30	12266
Ductile iron grating SW 18 mm, KTL-coated	500	249	20	823	6,90	12763
Ductile iron design grating METROPOLIS, black, KTL-coated	500	249	20	279	10,70	12275
Ductile iron longitudinal grating SW 9 mm, KTL-coated	500	249	20	951	9,40	12269
Ductile iron longitudinal grating SW 9 mm, galvanised	500	249	20	951	9,40	12369
G-TEC Ductile iron grating SW 2 x 85 x 9 mm, galvanised	500	249	20	595	7,90	12366

\* Not for use across the carriageway of highways or motorways in moving traffic.

## FASERFIX®KS 200, class E 600



GUGI-Ductile mesh grating MW 15/25 mm, black

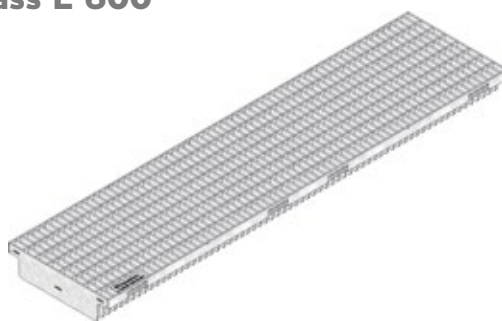

Mesh grating MW 11/30 mm

	Length mm	Width mm	Height mm	Intake cross-sect. cm <sup>2</sup> /m	Weight kg	Item-No. galvanised	Item-No. stainless steel
GUGI-Ductile mesh grating MW 15/25 mm, black	500	249	20	886	9,50	12068	-
GUGI-Ductile iron mesh grating, MW 15/25 mm, KTL-coated	500	249	20	886	9,70	12268	-
Mesh grating MW 11/30 mm	1000	249	20	1309	28,40	12071	12571
Mesh grating MW 11/30 mm	500	249	20	1309	14,60	12072	12572

The quality of stainless steel material corresponds to CNS 1.4301 or CNS 1.4307.  
Solid ductile iron covers (closed) can be found in the range SERVICE CHANNELS.

# FASERFIX®KS 200

## Gratings

### FASERFIX®KS 200, class F 900



Ductile iron grating,  
SW 20 mm, black



Ductile iron grating,  
SW 20 mm, KTL-coated

	Length mm	Width mm	Height mm	Intake cross-sect. cm <sup>2</sup> /m	Weight kg	Item No.
Ductile iron grating, SW 20 mm, black	500	249	20	823	10,40	12061
Ductile iron grating, SW 20 mm, KTL-coated	500	249	20	823	10,40	12261

# FASERFIX®KS 200

## Accessories

### Trash boxes

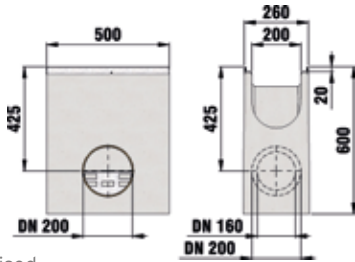

Trash box with galvanised bucket

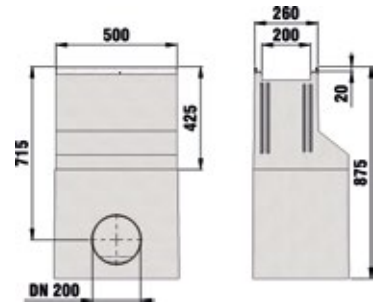

Trash box, 2-pieces, with galvanised mud bucket

	Length mm	Width mm	Height mm	Weight kg	Item-No. galvanised	Item-No. stainless steel
Trash box with galvanised bucket	500	260	600	72,20	12052	12552
Trash box, 2-pieces, with galvanised mud bucket	500	260	875	177,00	12054	-

The quality of stainless steel material corresponds to CNS 1.4301 or CNS 1.4307.

### End caps



End cap closed, FASERFIX KS type 01/ RECYFIX PLUS type 020/ RECYFIX STANDARD type 020



End cap closed, type 010



End cap closed, type 020



End cap with horizontal PVC-U pipe outlet DN/OD 160, galvanised, type 020

	Length mm	Width mm	Height mm	Weight kg	Item-No. galvanised	Item-No. stainless steel
End cap closed, FASERFIX KS type 01/ RECYFIX PLUS type 020/ RECYFIX STANDARD type 020	-	260	275	1,10	12081	12581
End cap closed, type 010	-	260	320	1,20	12082	12582
End cap closed, type 020	-	260	370	1,50	12083	12583
End cap, closed, type 110 F	-	260	110	0,40	3181	3681
End cap, closed, type 150 F	-	260	150	0,60	3182	3682
End cap, closed, type 200 F	-	260	200	0,80	3183	3683
End cap with horizontal PVC-U pipe outlet DN/OD 160, galvanised, type 01 - 010	-	260	320	1,50	12087	12587
End cap with horizontal PVC-U pipe outlet DN/OD 160, galvanised, type 020	-	260	370	1,70	12088	12588

The quality of stainless steel material corresponds to CNS 1.4301 or CNS 1.4307.



# FASERFIX®KS 200

## Accessories

### Further accessories



PVC-Connection  
DN/OD 200



Mud bucket for outlet  
DN/OD 160

	Length mm	Width mm	Height mm	Weight kg	Item No.
PVC-Connection DN/OD 200	-	-	-	0,80	907
Mud bucket for outlet DN/OD 160	-	-	180	0,80	2191
Locking handle for FASERFIX SUPER KS 200	219	28	-	0,30	98221
Universal sealant/adhesive Siga-Meltell® 220 black**	-	-	-	1,00	19051
Tubular pistol for universal sealant/adhesive Siga-Meltell® 220 black**	-	-	-	1,30	6891
Installation aid NW 200 (2 pieces required) - due to security reasons no return can be made	-	-	-	2,60	136202

\*\* Consumption for channel type O20: approx. 105 ml per joint.

# FASERFIX®KS 200

## Factory-made services



Cutting to length of NW 200



Cutting for gradient for all nominal widths



Drilling of connecting holes DN/OD 200



Factory-made insertion of PVC-U union connectors DN/OD 200



Fixing-system EP, empty pipe in the channel bottom, (2 pieces per metre)

	Length mm	Width mm	Height mm	Weight kg	Item No.
Cutting to length of NW 200	-	-	-	-	992
Mitre cuts NW 200 (price per cut, two cuts necessary)	-	-	-	-	997
Cutting for gradient for all nominal widths	-	-	-	-	890
Drilling of connecting holes DN/OD 200	-	-	-	-	974
Factory-made insertion of PVC-U union connectors DN/OD 200	-	-	-	-	984
Fixing-system EP, empty pipe in the channel bottom, (2 pieces per metre)	-	-	-	-	703
steel bars for fixing system EP (2 pieces per metre)	-	-	-	-	704

Grating options  
**FASERFIX KS 300**

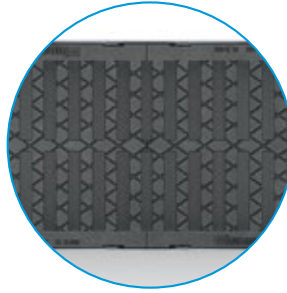

**Ductile iron gratings**  
Slot width: 2 x 140 x 18 mm



**G-TEC Ductile iron grating, KTL**  
Slot width: 2 x 141 x 9 mm

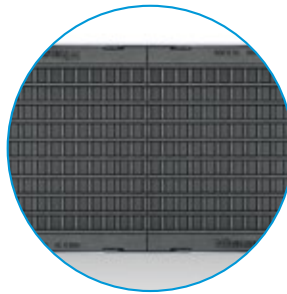
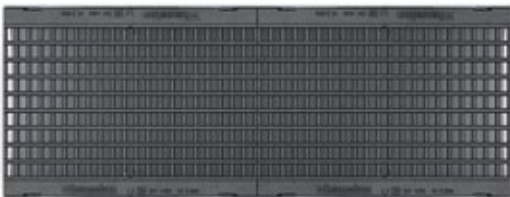

**GUGI-Ductile iron mesh gratings**  
Mesh width: 15 x 25 mm

<b>FASERFIX®SUPER</b>
<b>FASERFIX®KS</b>
<b>FASERFIX®BIG SLG</b>
<b>FASERFIX®BIG BL</b>
<b>RECYFIX®PLUS X</b>
<b>RECYFIX®NC</b>
<b>RECYFIX®MONOTEC</b>
<b>RECYFIX®HICAP®F</b>
<b>FASERFIX®POINT KS</b>
<b>SERVICE CHANNEL</b>

# FASERFIX®KS 300

## Channels

### FASERFIX®KS 300 up to load class E 600

Type 010

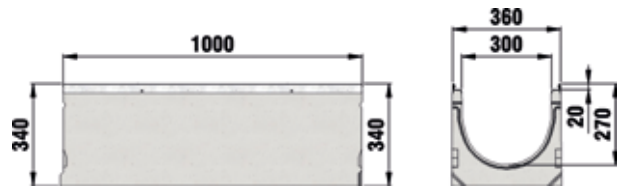

	Length mm	Width mm	Height mm	Internal channel cross-sect. cm <sup>2</sup>	Weight kg	Item No.
Type 010	1000	360	340	634	117,20	14040



# FASERFIX®KS 300

## Gratings

### FASERFIX®KS 300, class D 400\*



Ductile iron grating,  
SW 18 mm, black



Ductile iron grating,  
SW 18 mm, KTL-coated



G-TEC Ductile iron grating  
SW 2 x 141 x 9 mm, KTL-coated

	Length mm	Width mm	Height mm	Intake cross-sect. cm <sup>2</sup> /m	Weight kg	Item No.
Ductile iron grating, SW 18 mm, black	500	349	20	1317	12,92	14463
Ductile iron grating, SW 18 mm, KTL-coated	500	349	20	1317	12,50	14763
G-TEC Ductile iron grating SW 2 x 141 x 9 mm, KTL-coated	500	349	20	960	14,88	14266
G-TEC Ductile iron grating SW 2 x 141 x 9 mm, galvanised	500	349	20	960	15,11	14366

\* Not for use across the carriageway of highways or motorways in moving traffic.

### FASERFIX®KS 300, class E 600



GUGI-Ductile iron mesh grating,  
MW 15/25 mm, black



GUGI-Ductile iron mesh grating,  
MW 15/25 mm, KTL-coated

	Length mm	Width mm	Height mm	Intake cross-sect. cm <sup>2</sup> /m	Weight kg	Item No.
GUGI-Ductile iron mesh grating, MW 15/25 mm, black	500	349	20	1196	18,12	14068
GUGI-Ductile iron mesh grating, MW 15/25 mm, KTL-coated	500	349	20	1196	18,15	14268

# FASERFIX®KS 300

## Accessories

### Trash boxes



Trash box 2-parts  
with galvanised mud bucket

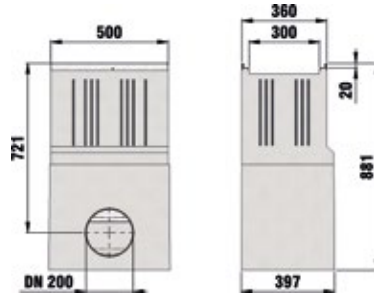

	Length mm	Width mm	Height mm	Weight kg	Item-No. galvanised	Item-No. stainless steel
Trash box 2-parts with galvanised mud bucket	500	360	881	178,50	14054	14554

The quality of stainless steel material corresponds to CNS 1.4301 or CNS 1.4307.

### End caps



End cap closed,  
type 340

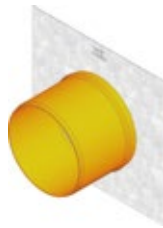

End cap with PVC-U pipe outlet  
DN/OD 200

	Length mm	Width mm	Height mm	Weight kg	Item No.
End cap closed, type 340	-	360	340	1,90	14085
End cap with PVC-U pipe outlet DN/OD 200	-	360	340	2,20	14087

The quality of stainless steel material corresponds to CNS 1.4301 or CNS 1.4307.

# FASERFIX®KS 300

## Further accessories



Extension part

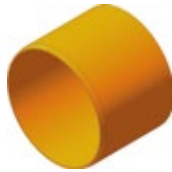

PVC-Connection  
DN/OD 200

	Length mm	Width mm	Height mm	Weight kg	Item No.
Extension part	510	390	400	81,70	4054
PVC-Connection DN/OD 200	-	-	-	0,80	907
Clip-locking handle for SUPER KS 300, galvanised, complete with bolts	-	-	-	0,30	98270
Universal sealant/adhesive Siga-Meltell® 220 black**	-	-	-	1,00	19051
Tubular pistol for universal sealant/adhesive Siga-Meltell® 220 black**	-	-	-	1,30	6891
Installation aid NW 300 (2 pieces required) - due to security reasons no return can be made	-	-	-	3,70	136242

\*\* Consumption for channel type O10: approx. 150 ml per joint.

## Factory-made services



Cutting to length of NW 300



Mitre cuts NW 300  
(price per cut, two cuts  
necessary)



Cutting for gradient  
for all nominal widths



Drilling of connecting holes  
DN/OD 200



Factory-made insertion  
of PVC-U union connectors  
DN/OD 200



Fixing-system EP, empty pipe  
in the channel bottom,  
(2 pieces per metre)

	Length mm	Width mm	Height mm	Weight kg	Item No.
Cutting to length of NW 300	-	-	-	-	993
Mitre cuts NW 300 (price per cut, two cuts necessary)	-	-	-	-	998
Cutting for gradient for all nominal widths	-	-	-	-	890
Drilling of connecting holes DN/OD 200	-	-	-	-	974
Factory-made insertion of PVC-U union connectors DN/OD 200	-	-	-	-	984
Drilling of connection holes DN/OD 315	-	-	-	-	978
Factory-made insertion of PVC-U union connectors DN/OD 315 (incl. drilling)	-	-	-	-	979
Fixing-system EP, empty pipe in the channel bottom, (2 pieces per metre)	-	-	-	-	703
steel bars for fixing system EP (2 pieces per metre)	-	-	-	-	704