

RECYFIX STANDARD

Drainage channel for domestic applications around the house and garden.

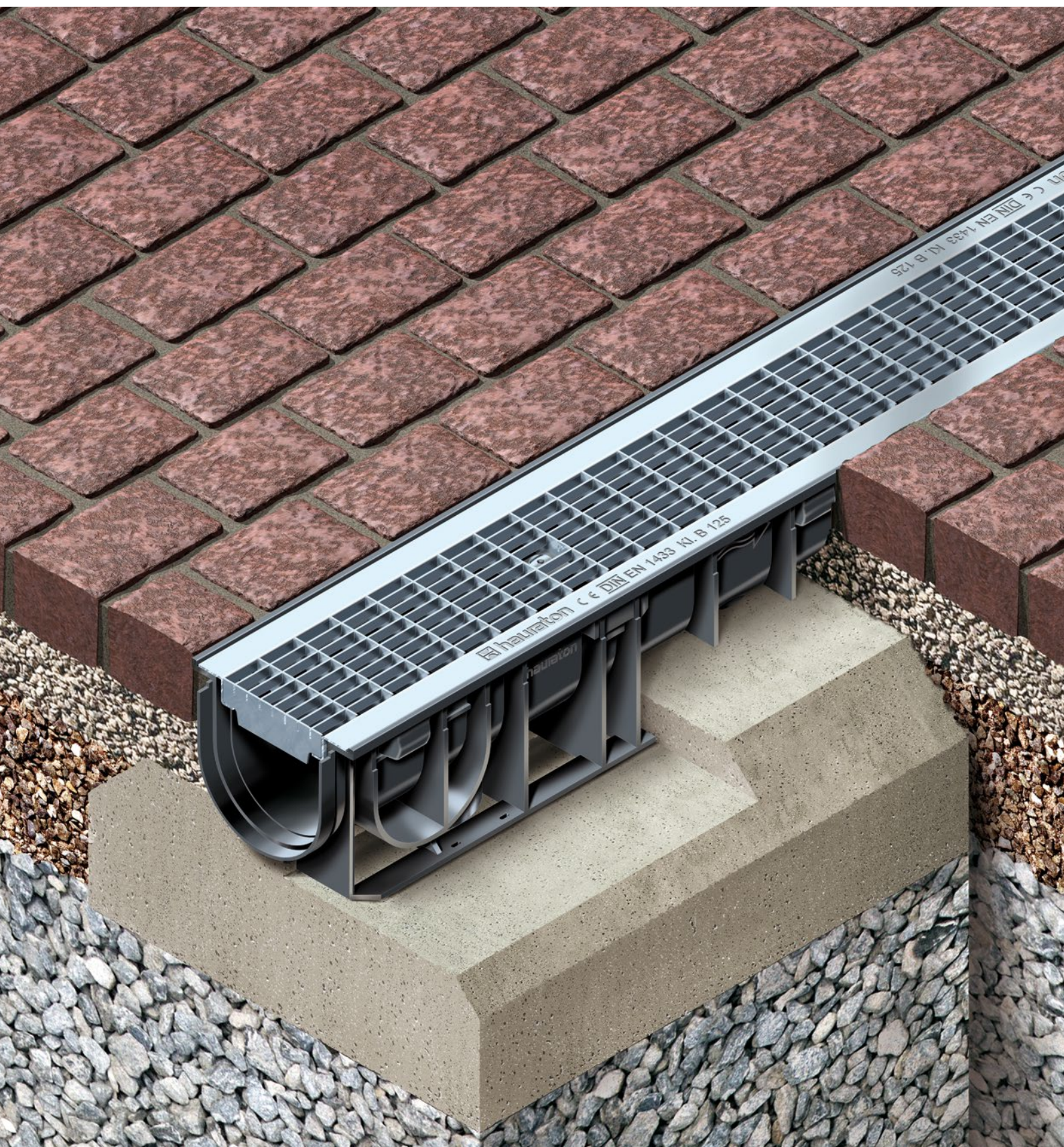



**Private estate,
Germany**

RECYFIX STANDARD

Drainage channel for domestic applications around the house and garden.

1 Requirements

Drainage channels in private areas have to

- permanently withstand the daily stress of cars and pedestrians
- be easy to transport and install
- withstand weather influences (frost, heat, humidity)
- be optically attractive
- be in accordance with DIN EN 1433

2 Application areas

- predominantly private areas
- driveways
- courtyards
- terraces
- gardens
- parks

3 Solutions

Therefore RECYFIX STANDARD channels are suitable for the drainage of private areas

- high stability and functionality
- low weight
- preformed vertical and horizontal outlets
- nominal sizes from 100 to 300 mm with different heights
- stable gratings in loading classes A 15 up to C 250 according to DIN EN 1433



Public area, Romania



Water fun park



Veszprem Arena in Hungary



Spa Fürthermare in Fürth, Germany



Private house



Street in Hungary

RECYFIX®
PRO

RECYFIX®
PLUS

RECYFIX®
STANDARD

Facade Drainage

SLOTTED
CHANNELS

RECYFIX® POINT
FASERFIX® POINT

RECYFIX®
GREEN

LINEFIX

TOP X

YOUR BENEFITS WITH RECYFIX STANDARD

FRAME SYSTEM

- PP frame to stop lateral movements
- enables flush connection with gratings which prevents injuries

= QUALITY & PERFORMANCE ASSURED



HIGH-GRADE MATERIAL

- **RECYFIX** - stable and almost unbreakable
- elastic and especially robust material
- withstands high loads and temperature differences in daily use
- 100 % recycled composite body (and also 100 % recyclable)
→ 100 % environmentally friendly
- 0 % water absorption
- smooth inner surface for superior flow characteristics
- PP channel body can be cut, drilled and worked easily on site

= QUALITY & PERFORMANCE ASSURED



LOW WEIGHT ENSURES EASY HANDLING ON SITE

- much lighter than channels made of polymer/resin concrete
- easy transport and installation

= TIME & COST SAVINGS



NUMEROUS GRATING OPTIONS

- made of ductile iron, galvanised or stainless steel
- narrow slot width for pedestrian areas available
- stable gratings in loading classes A 15 up to C 250 according to DIN EN 1433

= DESIGN FLEXIBILITY



PRE-ASSEMBLED READY FOR INSTALLATION

- channel and grating = one part
- no spare parts
- easy handling in stock and on construction site
- cost-efficient transport

= BETTER GROSS MARGIN



HIGH RESISTANCE

- high resistance against frost, de-icing salt and UV-rays
- withstands high temperature differences
- for climate ranges from - 50 °C to + 80 °C and more

= QUALITY ASSURED / LONGEVITY



IDEAL FOR ...

domestic applications around the house and garden, such as predominantly private areas, driveways, courtyards, gardens and parks.

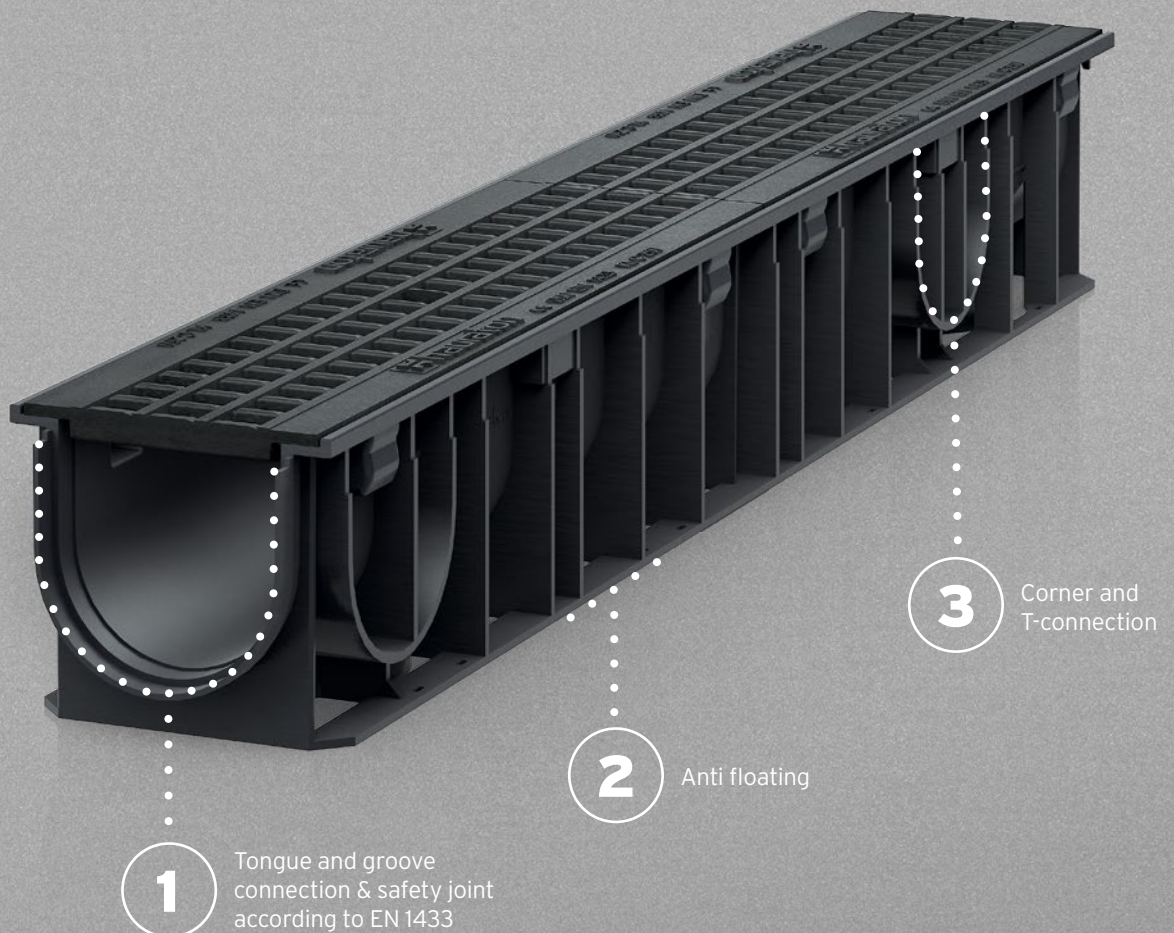

The Original

RECYFIX STANDARD

Drainage channel for domestic applications around the house and garden.

RECYFIX STANDARD channels meet the requirements of DIN EN 1433 and are suitable for the following load categories:



Category A 15, Load class 15 KN

Trafficked areas, which are exclusively used by pedestrians and cyclists



Category B 125, Load class 125 kN

Sidewalks, pedestrian areas and comparable areas, car parks or car parking decks



Category C 250, Load class 250 KN

Sidewalk channel areas and untraveled side panels or similar

If in doubt, the higher category should be used.

Numerous grating options, for example GUGI-Ductile iron mesh gratings

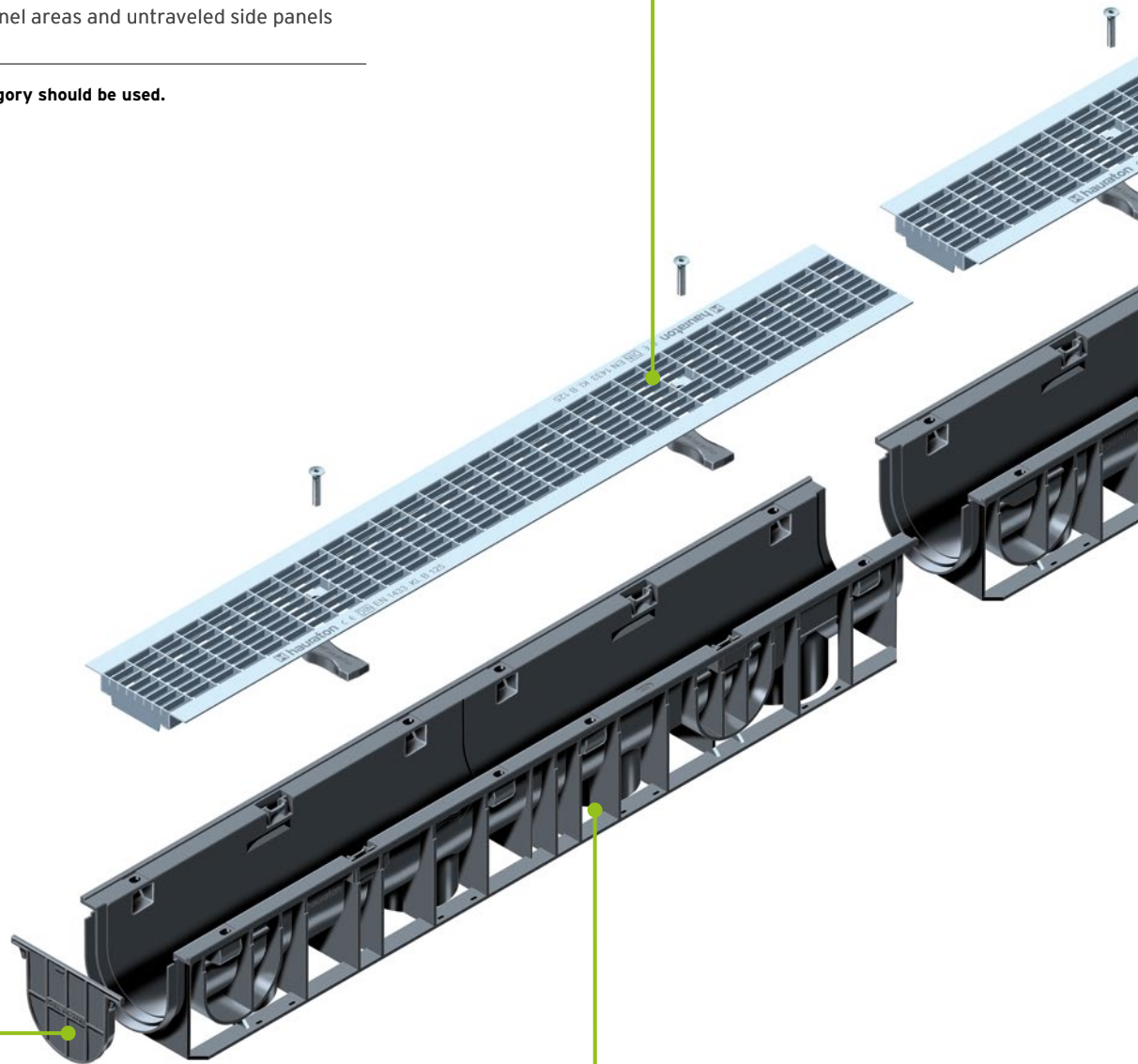

End caps without outlet

Channels made of PP, according to DIN V 19580 / EN 1433, CE-conform, with tongue and groove connection for exact installation

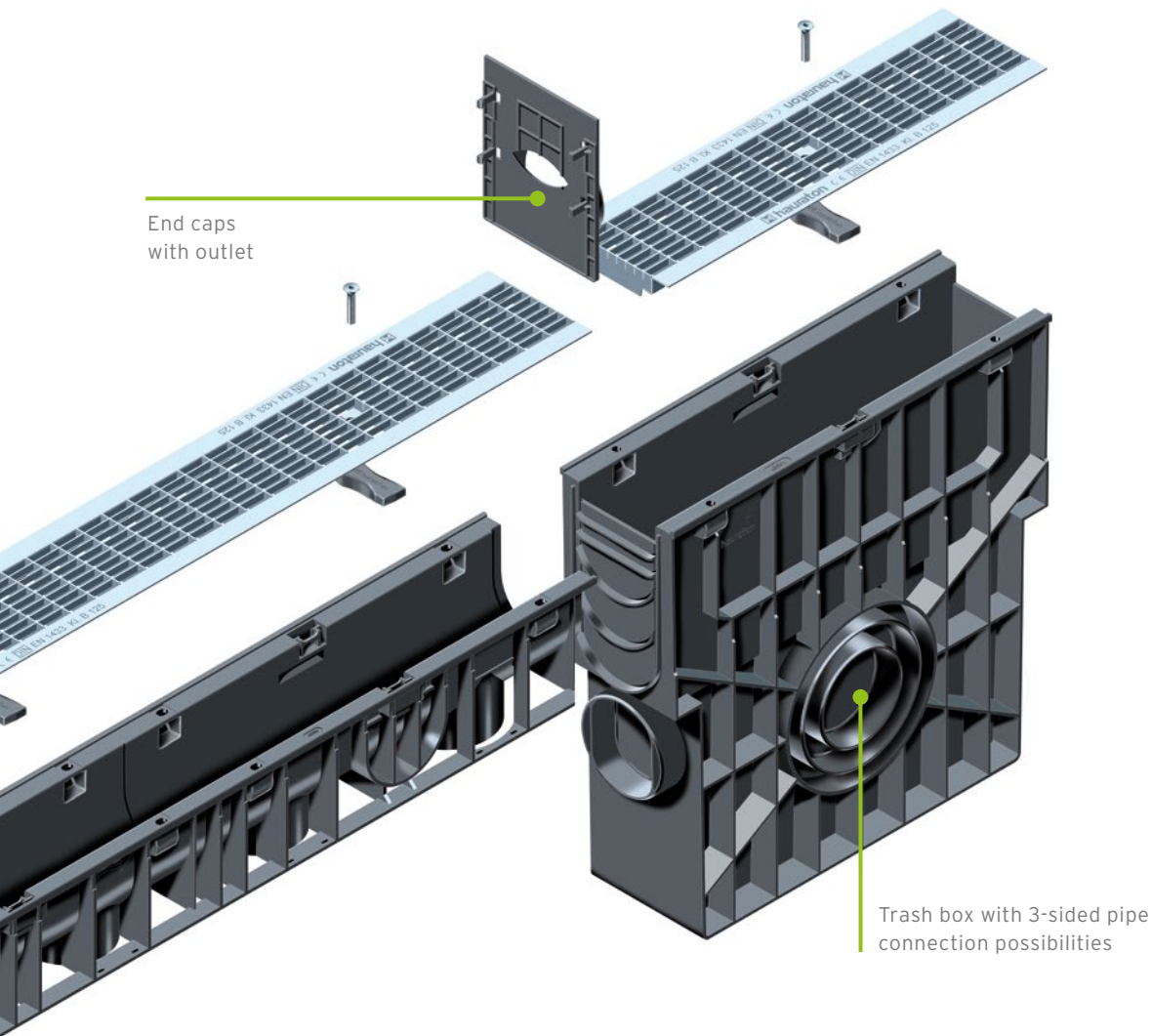

The construction widths and heights of the **RECYFIX STANDARD**:



Nominal width	100			150			200			300		
Type 60	150	60	40	-	-	-	-	-	-	-	-	-
Type 80	150	80	60	-	-	-	-	-	-	-	-	-
Type 100	-	-	-	210	100	79	256	100	79	-	-	-
Type 01	150	134	106	210	192	164	-	-	-	350	292	256
Type 010	150	185	157	-	-	-	256	185	156	420	381	327
Type 020	-	-	-	-	-	-	256	235	207	-	-	-

Width/height/inner height (in mm)

RECYFIX® PRO

RECYFIX® PLUS

RECYFIX® STANDARD

Facade Drainage

SLOTTED CHANNELS

RECYFIX® POINT
FASERFIX® POINT

RECYFIX® GREEN

LINEFIX

TOP X

Grating options

RECYFIX STANDARD 100

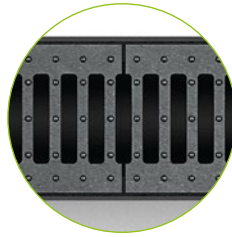

Ductile iron gratings

Slot width: 80 x 14 mm

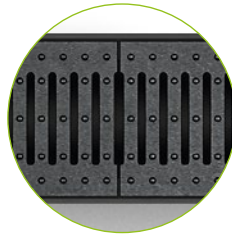

Ductile iron gratings

Slot width: 80 x 6 mm

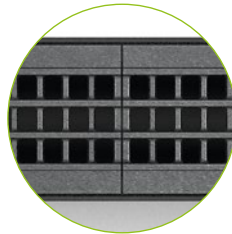

GUGI ductile iron gratings

Mesh width: 15 x 25 mm

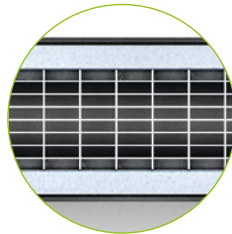

Mesh gratings, galvanised and stainless steel

Mesh width: 30 x 10 mm

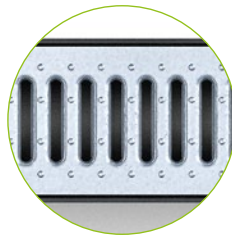

Slotted gratings, galvanised and stainless steel

Slot width: 75 x 9 mm

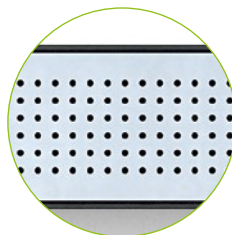

Perforated gratings, stainless steel

Hole diametre: 6 mm

RECYFIX®STANDARD 100

Combi article

RECYFIX®STANDARD 100, class A 15

Type 01 with perforated grating
"Elegance", locked

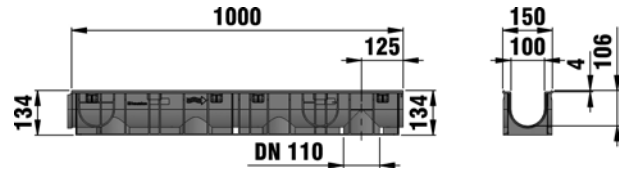
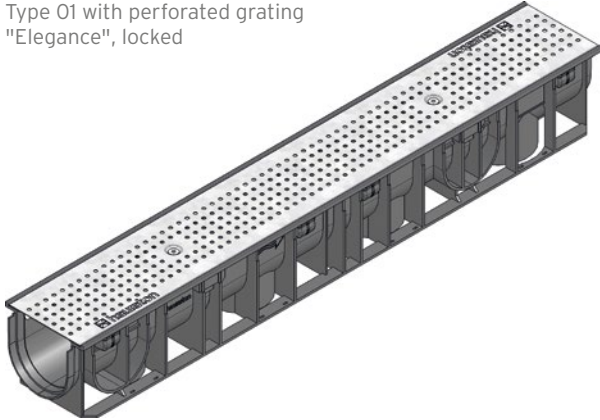

Type 010 with perforated grating
"Elegance", locked

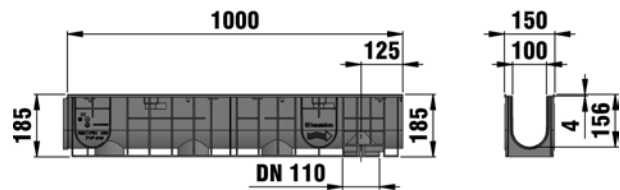
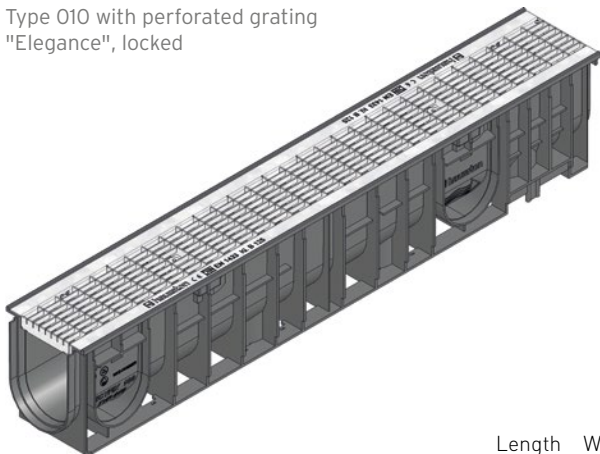

	Length mm	Width mm	Height mm	Internal channel cross-sect. cm ²	Intake cross-sect. cm ² /m	Weight kg	Item-No. galvanised	Item-No. stainless steel
Type 01 with perforated grating "Elegance", locked	1000	150	134	92	102	3,90	41270	41240
Type 0105 with perforated grating "Elegance", locked	500	150	134	92	102	2,00	41277	41247
Type 010 with perforated grating "Elegance", locked	1000	150	185	142	102	4,50	41272	41242
Type 01005 with perforated grating "Elegance", locked	500	150	185	142	102	2,40	41278	41248
Type 60 with perforated grating "Elegance", locked	1000	150	60	35	102	3,00	41274	41244
Type 80 with perforated grating "Elegance", locked	1000	150	80	55	102	3,40	41276	41246

Type 60/type 80 with preformed outlet DN/OD 75.

The quality of stainless steel material corresponds to CNS 1.4301 or CNS 1.4307.

RECYFIX® STANDARD 100

RECYFIX® STANDARD 100, trafficable

Type 01 with mesh grating
MW 30/10 mm, locked

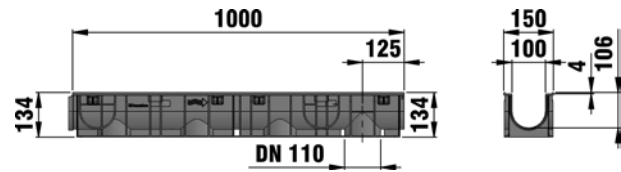
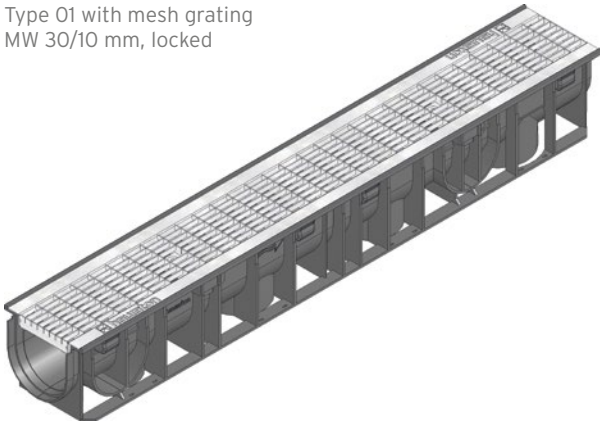

Type 010 with slotted grating
SW 9 mm, locked

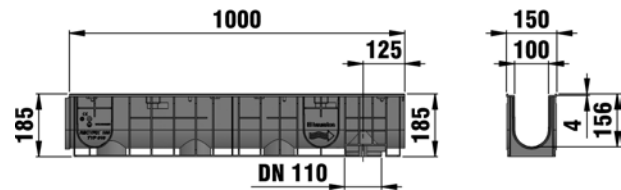

	Length mm	Width mm	Height mm	Internal channel cross-sect. cm ²	Intake cross-sect. cm ² /m	Weight kg	Item-No. galvanised	Item-No. stainless steel
Type 01 with mesh grating MW 30/10 mm, locked	1000	150	134	92	650	4,60	40232	-
Type 0105 with mesh grating MW 30/10 mm, locked	500	150	134	92	650	2,30	40262	-
Type 010 with mesh grating MW 30/10 mm, locked	1000	150	185	142	650	5,30	40297	-
Type 01005 with mesh grating MW 30/10 mm, locked	500	150	185	142	650	2,70	40267	-
Type 60 with mesh grating MW 30/10 mm, locked*	1000	150	60	35	650	3,70	40237	-
Type 80 with mesh grating MW 30/10 mm, locked	1000	150	80	55	650	4,20	40247	-
Type 01 with slotted grating SW 9 mm, locked	1000	150	134	92	280	4,00	40231	41200
Type 0105 with slotted grating SW 9 mm, locked	500	150	134	92	280	1,90	40261	41207
Type 010 with slotted grating SW 9 mm, locked	1000	150	185	142	280	4,60	40296	41202
Type 01005 with slotted grating SW 9 mm, locked	500	150	185	142	280	2,60	40266	41208
Type 60 with slotted grating SW 9 mm, locked*	1000	150	60	35	280	3,00	40236	41204
Type 80 with slotted grating SW 9 mm, locked*	1000	150	80	55	280	3,50	40246	41206

* For frequently used areas we recommend FASERFIX KS channels shallow (see CIVILS).
Type 60/type 80 with preformed outlet DN/OD 75.
The quality of stainless steel material corresponds to CNS 1.4301 or CNS 1.4307.

RECYFIX®
PRO

RECYFIX®
PLUS

RECYFIX®
STANDARD

Facade Drainage

SLOTTED
CHANNELS

RECYFIX® POINT
FASERFIX® POINT

RECYFIX®
GREEN

LINEFIX

TOP X

RECYFIX® STANDARD 100

Combi article

RECYFIX® STANDARD 100, class B 125

Type 01 with mesh grating
MW 30/10 mm, galvanised,
locked

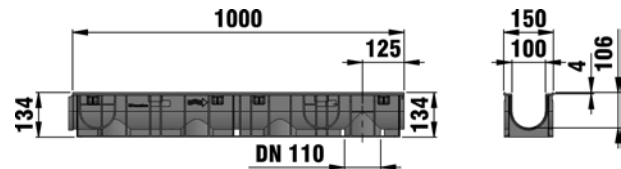
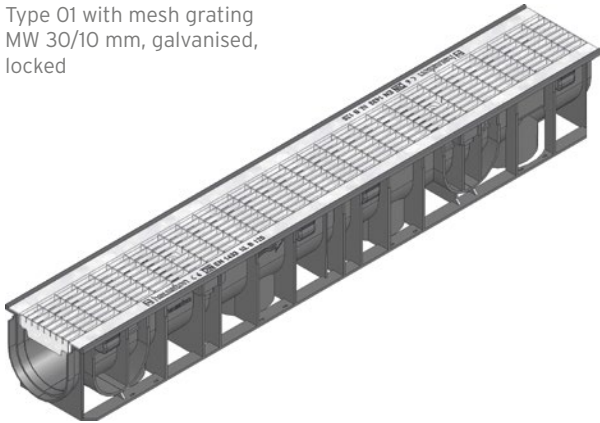

Type 010 with mesh grating
MW 30/10 mm, galvanised,
locked

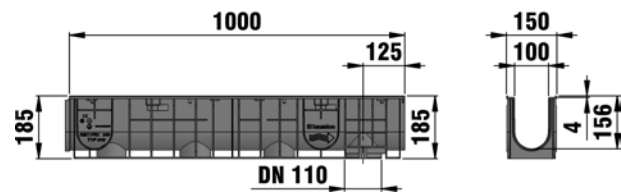
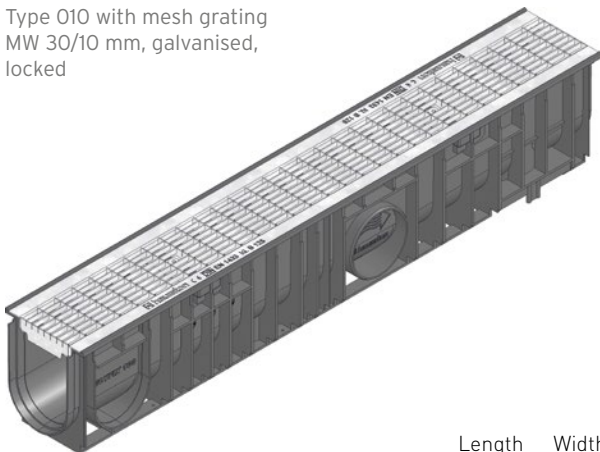

	Length mm	Width mm	Height mm	Internal channel cross-sect. cm ²	Intake cross-sect. cm ² /m	Weight kg	Item-No. galvanised	Item-No. stainless steel
Type 01 with mesh grating MW 30/10 mm, galvanised, locked	1000	150	134	92	650	5,10	41220	41210
Type 0105 with mesh grating MW 30/10 mm, locked	500	150	134	92	650	2,50	41227	41217
Type 010 with mesh grating MW 30/10 mm, galvanised, locked	1000	150	185	142	650	5,70	41222	41212
Type 01005 with mesh grating MW 30/10 mm, galvanised, locked	500	150	185	142	650	2,90	41228	41218
Type 80 with mesh grating MW 30/10 mm, galvanised, locked	1000	150	80	55	650	5,10	41226	41216

* For frequently used areas we recommend FASERFIX KS channels shallow (see CIVILS).

Type 60/type 80 with preformed outlet DN/OD 75.

The quality of stainless steel material corresponds to CNS 1.4301 or CNS 1.4307.

RECYFIX® STANDARD 100

RECYFIX® STANDARD 100, class C 250

Type 01 with ductile iron grating
SW 14 mm, black, locked

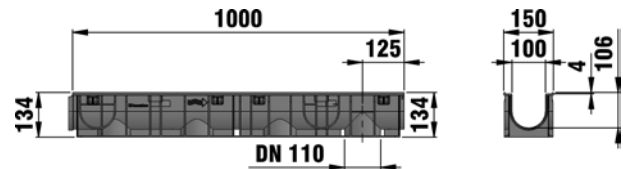
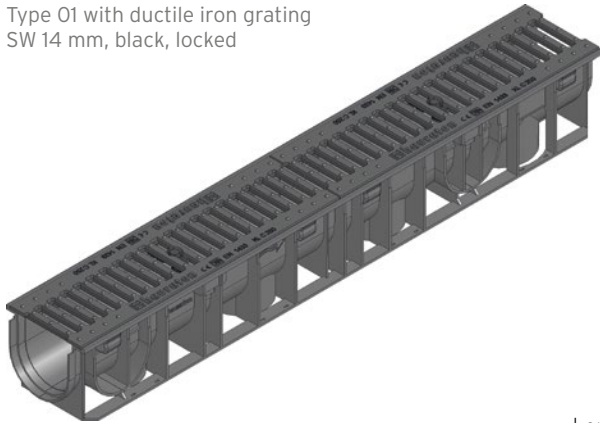

	Length mm	Width mm	Height mm	Internal channel cross-sect. cm ²	Intake cross-sect. cm ² /m	Weight kg	Item No.
Type 01 with ductile iron grating SW 14 mm, black, locked	1000	150	134	92	450	8,20	40233
Type 0105 with ductile iron grating SW 14 mm, black, locked	500	150	134	92	450	3,80	40263
Type 010 with ductile iron grating SW 14 mm, black, locked	1000	150	185	142	450	8,80	40298
Type 01005 with ductile iron grating SW 14 mm, black, locked	500	150	185	142	450	4,50	40268
Type 60 with ductile iron grating SW 14 mm, black, locked*	1000	150	60	35	450	7,20	40238
Type 80 with ductile iron grating SW 14 mm, black, locked	1000	150	80	55	450	7,70	40248
Type 01 with ductile iron grating, SW 6 mm, locked	1000	150	134	92	290	8,30	41230
Type 0105 with ductile iron grating, black, SW 6 mm, locked	500	150	134	92	290	4,30	41237
Type 010 with ductile iron grating, SW 6 mm, locked	1000	150	185	142	290	8,70	41232
Type 01005 with ductile iron grating, black, SW 6 mm, locked	500	150	185	142	290	4,50	41238
Type 60 with ductile iron grating, black, SW 6 mm, locked	1000	150	60	35	290	7,40	41234
Type 80 with ductile iron grating, black, SW 6 mm, locked	1000	150	80	55	290	7,70	41236
Type 01 with GUGI-Ductile iron mesh grating MW 15/25 mm, black, locked	1000	150	134	92	444	7,10	40234
Type 0105 with GUGI-Ductile iron mesh grating MW 15/25 mm, black, locked	500	150	134	92	444	3,50	40264
Type 010 with GUGI-Ductile iron mesh grating MW 15/25 mm, black, locked	1000	150	185	142	444	8,50	40299
Type 01005 with GUGI-Ductile iron mesh grating MW 15/25 mm, black, locked	500	150	185	142	444	4,30	40269
Type 60 with GUGI-Ductile iron mesh grating MW 15/25 mm, black, locked*	1000	150	60	35	444	6,90	40239
Type 80 with GUGI-Ductile iron mesh grating MW 15/25 mm, black, locked	1000	150	80	55	444	5,50	40253

* For frequently used areas we recommend FASERFIX KS channels shallow (see CIVILS).
Type 60/type 80 with preformed outlet DN/OD 75.

RECYFIX®
PRO

RECYFIX®
PLUS

RECYFIX®
STANDARD

Facade Drainage

SLOTTED
CHANNELS

RECYFIX® POINT
FASERFIX® POINT

RECYFIX®
GREEN

LINEFIX

TOP X

RECYFIX® STANDARD 100

Accessories

Trash boxes

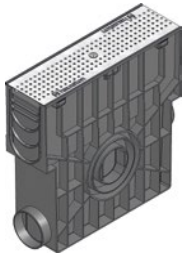

Trash box with perforated grating
Ø 6 mm, class A 15, locked

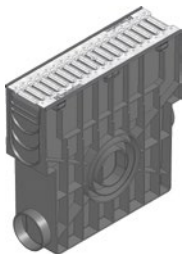
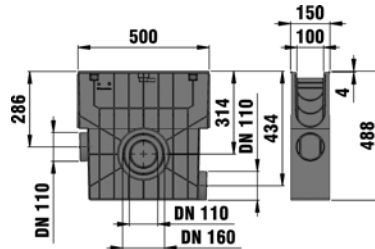

Trash box with mud bucket
and slotted grating, galvanised,
trafficable, locked

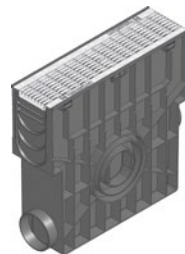

Trash box with plastic bucket,
with mesh grating, MW 30/10
mm trafficable, locked

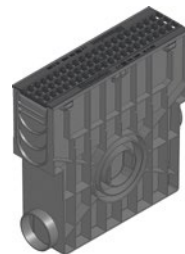

Trash box with plastic bucket
and GUGI-Ductile iron mesh
grating MW 15/25 mm, black,
class C 250, locked

	Length mm	Width mm	Height mm	Weight kg	Item-No. galvanised	Item-No. stainless steel
Trash box with perforated grating Ø 6 mm, class A 15, locked	500	150	488	5,20	41251	41249
Trash box with mud bucket and slotted grating, galvanised, trafficable, locked	500	150	488	5,20	48055	48056
Trash box with plastic bucket, with mesh grating, MW 30/10 mm trafficable, locked	500	150	488	5,60	48057	-
Trash box with plastic bucket, with mesh grating, MW 30/10 mm, class B 125, locked	500	150	488	5,80	48059	48058
Trash box with plastic bucket and GUGI-Ductile iron mesh grating MW 15/25 mm, black, class C 250, locked	500	150	488	7,20	40259	-
Trash box with plastic bucket, ductile iron grating SW 14 mm, black, class C 250, locked	500	150	488	7,10	48053	-
Trash box with plastic bucket, ductile iron grating SW 6 mm, black, class C 250, locked	500	150	488	7,50	48054	-

The quality of stainless steel material corresponds to CNS 1.4301 or CNS 1.4307.

RECYFIX® STANDARD 100

End caps



End cap, closed for type 01



End cap closed for type 010



End cap combined made of PP with outlet DN/OD 110, type 010

	Length mm	Width mm	Height mm	Weight kg	Item No.
End cap, closed for type 01	-	150	108	0,00	48081
End cap with outlet DN/OD 110 for type 01	-	148	185	0,10	48091
End cap closed for type 010	-	150	160	0,00	40282
End cap combined made of PP with outlet DN/OD 110, type 010	-	148	185	0,10	40283
End cap closed, made of PP, for type 60	-	147	44	0,00	40284
End cap closed, made of PP, for type 80	-	147	64	0,00	40291

Further accessories



Foul air trap, vertical, DN/OD 110



Foul air trap set, vertical DN/OD 110 for RECYFIX 100



Foul air trap for RECYFIX trash box 100



Mud bucket vertical made of modified composite for outlet DN/OD 110, black

	Length mm	Width mm	Height mm	Weight kg	Item No.
Foul air trap, vertical, DN/OD 110	-	187	181	0,60	40295
Foul air trap set, vertical DN/OD 110 for RECYFIX 100	-	-	203	0,40	40294
Foul air trap DN/OD 110, outside	-	-	-	0,40	961
Foul air trap for RECYFIX trash box 100	75	78	135	0,10	967
Adaptor for DN/OD 75 to PVC-U pipe DN/OD 110	-	-	-	0,10	1193
Mud bucket vertical made of modified composite for outlet DN/OD 110, black	100	100	85	0,00	40293
Step Fall Adapter for step slope, from type 01 to type 010	174	98	86	0,20	41290
Universal sealant/adhesive Siga-Meltell® 220 black**	-	-	-	1,00	19051
Tubular pistol for universal sealant/adhesive Siga-Meltell® 220 black**	-	-	-	1,30	6891
Holesaw, Ø 102 mm, with tool holder for a drill	-	-	-	0,60	980

****Amount needed for Type 010: approx. 18 ml per joint**

RECYFIX®
PRO

RECYFIX®
PLUS

RECYFIX®
STANDARD

Facade Drainage

SLOTTED
CHANNELS

RECYFIX® POINT
FASERFIX® POINT

RECYFIX®
GREEN

LINEFIX

TOP X

Grating options

RECYFIX STANDARD 200

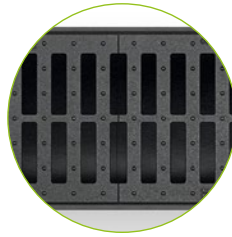

Ductile iron gratings
Slot width: 2 x 85 x 20 mm

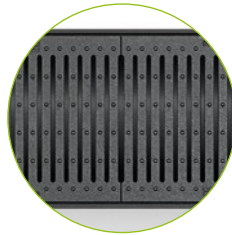

Ductile iron gratings
Slot width: 180 x 6 mm

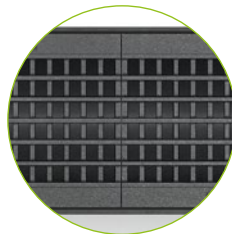
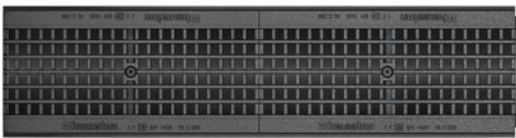

GUGI ductile iron gratings
Mesh width: 15 x 25 mm

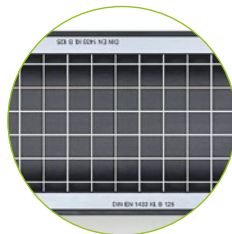
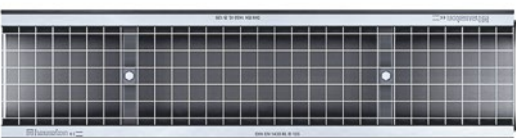

Mesh gratings
Mesh width: 30 x 30 mm

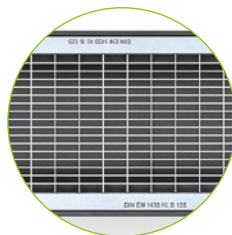
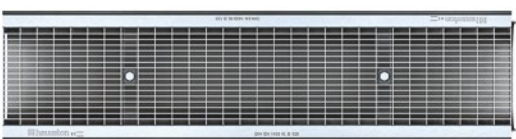

Mesh gratings, galvanised
Mesh width: 30 x 10 mm

RECYFIX®STANDARD 200

Combi article

RECYFIX®STANDARD 200, class B 125

Type 010 with mesh grating MW 30/30 mm, galvanised, locked

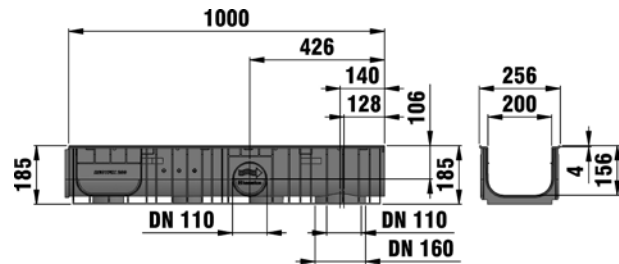
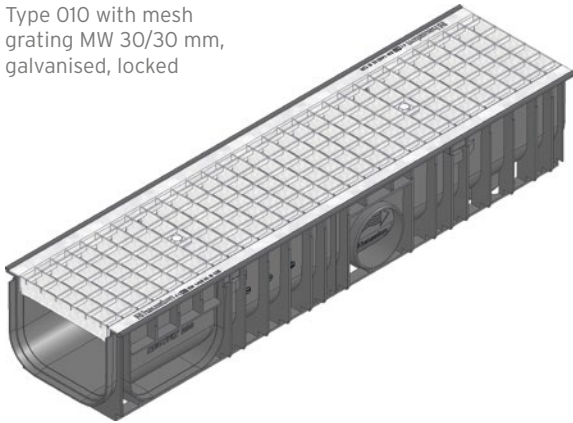

Type 020 with mesh grating MW 30/10 mm, galvanised, locked

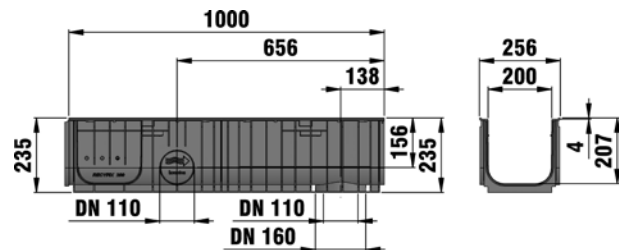
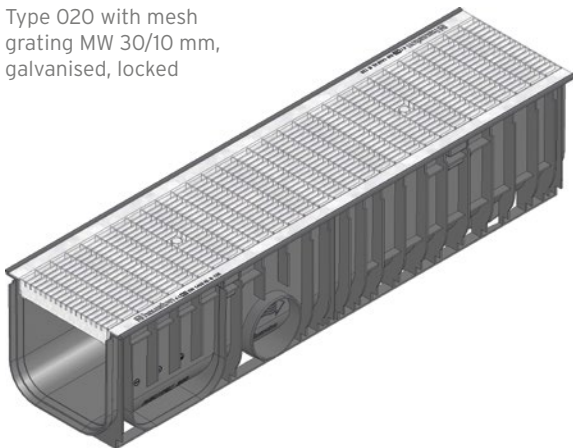

	Length mm	Width mm	Height mm	Internal channel cross-sect. cm ²	Intake cross-sect. cm ² /m	Weight kg	Item No.
Type 010 with mesh grating MW 30/30 mm, galvanised, locked	1000	256	185	294	1620	9,30	40672
Type 020 with mesh grating MW 30/30 mm, galvanised, locked	1000	256	235	394	1620	9,70	40676
Type 100 with mesh grating MW 30/30 mm, galvanised, locked	1000	256	100	150	1620	8,30	40635
Type 010 with mesh grating MW 30/10 mm, galvanised, locked	1000	256	185	294	1442	11,20	40685
Type 020 with mesh grating MW 30/10 mm, galvanised, locked	1000	256	235	394	1442	11,30	40686
Type 100 with mesh grating MW 30/10 mm, galvanised, locked	1000	256	100	150	1442	10,10	40636

RECYFIX® STANDARD 200

RECYFIX® STANDARD 200, class C 250

Type 020 with ductile iron grating 2 x 85/20 mm, black, locked

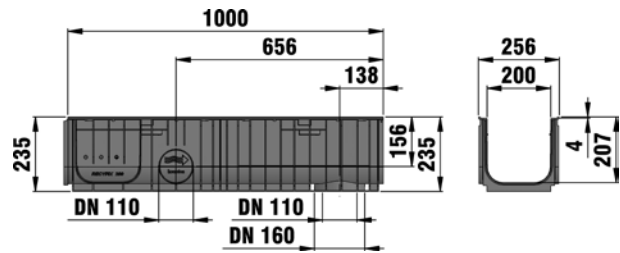

Type 010 with GUGI-Ductile iron mesh grating MW 15/25 mm, black, locked

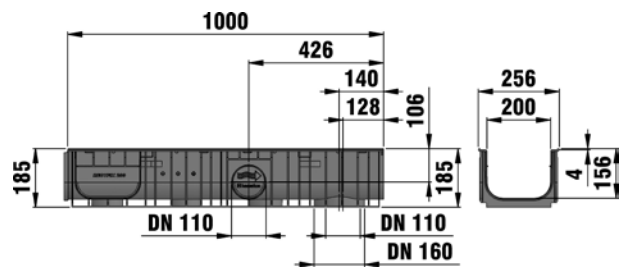
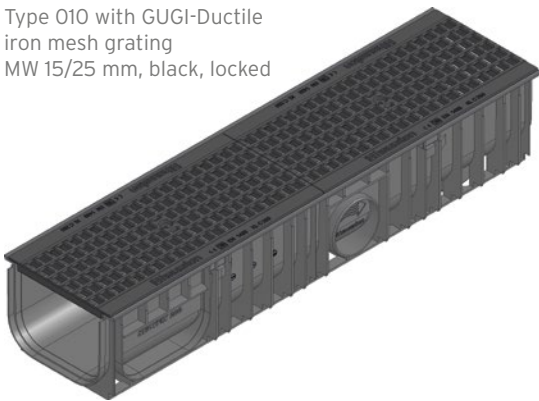

	Length mm	Width mm	Height mm	Internal channel cross-sect. cm ²	Intake cross-sect. cm ² /m	Weight kg	Item No.
Type 010 with ductile iron grating 2 x 85/20 mm, black, locked	1000	256	185	294	822	15,00	40660
Type 020 with ductile iron grating 2 x 85/20 mm, black, locked	1000	256	235	394	822	15,30	40661
Type 100 with ductile iron grating 2 x 85/20 mm, black, locked	1000	256	100	150	822	13,90	40640
Type 010 with ductile iron grating, SW 6 mm, locked	1000	256	185	294	557	17,60	40688
Type 020 with ductile iron grating, SW 6 mm, locked	1000	256	235	394	557	18,10	40689
Type 100 with ductile iron grating, SW 6 mm, locked	1000	256	100	150	557	16,70	40687
Type 010 with GUGI-Ductile iron mesh grating MW 15/25 mm, black, locked	1000	256	185	294	825	15,40	40665
Type 020 with GUGI-Ductile iron mesh grating MW 15/25 mm, black, locked	1000	256	235	394	825	17,00	40666
Type 100 with GUGI-Ductile iron mesh grating MW 15/25 mm, black, locked	1000	256	100	150	825	15,60	40641

RECYFIX®
PRO

RECYFIX®
PLUS

RECYFIX®
STANDARD

Facade Drainage

SLOTTED
CHANNELS

RECYFIX® POINT
FASERFIX® POINT

RECYFIX®
GREEN

LINEFIX

TOP X

RECYFIX® STANDARD 200

Accessories

Trash boxes

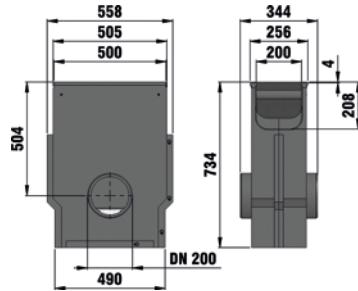

Trash box with mesh grating
MW 30/30 mm, galvanised,
class B 125, locked



Trash box with GUGI-Ductile
iron mesh grating MW 15/25 mm,
black, class C 250, locked

	Length mm	Width mm	Height mm	Weight kg	Item No.
Trash box with mesh grating MW 30/30 mm, galvanised, class B 125, locked	500	256	734	28,30	40656
Trash box with mesh grating MW 30/10 mm, galvanised, class B 125, locked	500	256	734	29,30	40657
Trash box with GUGI-Ductile iron mesh grating MW 15/25 mm, black, class C 250, locked	500	256	734	31,70	40653
Trash box with ductile iron grating 2 x 85/20 mm, black, class C 250, locked	500	256	734	30,60	40654
Trash box with galvanised mud bucket and ductile iron grating, SW 6 mm, locked	500	256	734	32,30	40693

RECYFIX® STANDARD 200

End caps



End cap combined made of PP closed / with outlet DN/OD 110, Type 010



End cap closed, FASERFIX KS type 01/RECYFIX PLUS type 020/RECYFIX STANDARD type 020

	Length mm	Width mm	Height mm	Weight kg	Item No.
End cap combined made of PP closed / with outlet DN/OD 110, Type 010	-	254	199	0,20	40792
End cap closed, FASERFIX KS type 01/RECYFIX PLUS type 020/ RECYFIX STANDARD type 020	-	260	275	1,10	12081
End cap closed, type 100	-	262	100	0,10	40690

Further accessories



Foul air trap, vertical, DN/OD 110

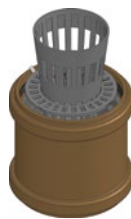

Foul air trap set, vertical DN/OD 110 for RECYFIX 100

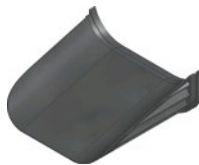

Step Fall Adapter for step slope, from type 010 to type 020

	Length mm	Width mm	Height mm	Weight kg	Item No.
Foul air trap, vertical, DN/OD 110	-	187	181	0,60	40295
Foul air trap set, vertical DN/OD 110 for RECYFIX 100	-	-	203	0,40	40294
Step Fall Adapter for step slope, from type 010 to type 020	194	208	89	0,40	49590
Universal sealant/adhesive Siga-Meltell® 220 black**	-	-	-	1,00	19051
Tubular pistol for universal sealant/adhesive Siga-Meltell® 220 black**	-	-	-	1,30	6891
Holesaw, Ø 102 mm, with tool holder for a drill	-	-	-	0,60	980

****Amount needed for Type 020: approx. 22 ml per joint**

RECYFIX®
PRO

RECYFIX®
PLUS

RECYFIX®
STANDARD

Facade Drainage

SLOTTED
CHANNELS

RECYFIX® POINT
FASERFIX® POINT

RECYFIX®
GREEN

LINEFIX

TOP X

Grating options
RECYFIX STANDARD 300

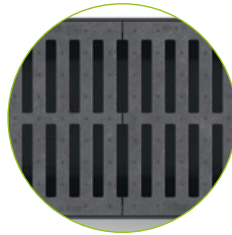

Ductile iron gratings

Slot width: 2 x 127 x 18 mm

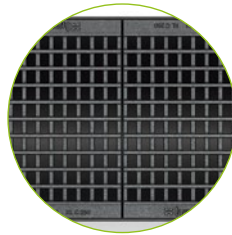
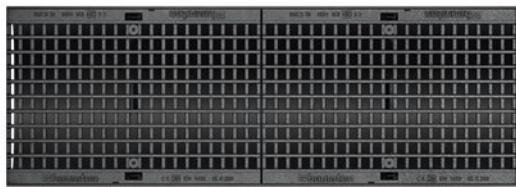

GUGI ductile iron gratings

Mesh width: 15 x 25 mm

RECYFIX® PRO
RECYFIX® PLUS
RECYFIX® STANDARD
Facade Drainage
SLOTTED CHANNELS
RECYFIX® POINT FASERFIX® POINT
RECYFIX® GREEN
LINEFIX
TOP X

RECYFIX®STANDARD 300

Combi article

RECYFIX®STANDARD 300, class B 125

Type 01 with GUGI-Ductile iron mesh grating, MW 15/25 mm, black, locked

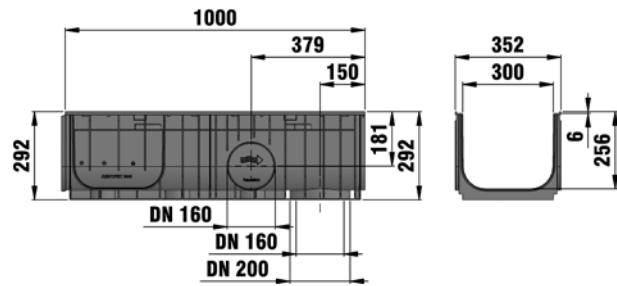
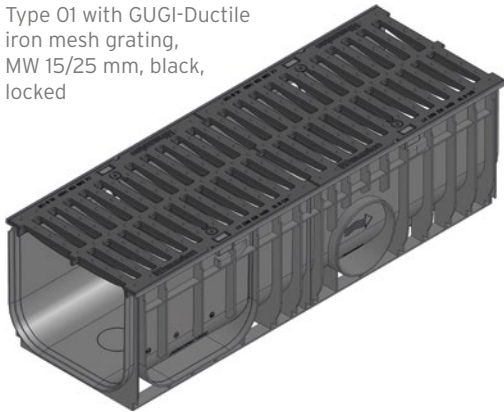

	Length mm	Width mm	Height mm	Internal channel cross-sect. cm ²	Intake cross-sect. cm ² /m	Weight kg	Item No.
Type 01 with GUGI-Ductile iron mesh grating, MW 15/25 mm, black, locked	1000	352	292	725	-	22,77	32864

RECYFIX®STANDARD 300, class C 250

Type 010 with GUGI-Ductile iron mesh grating, MW 15/25 mm, black, locked

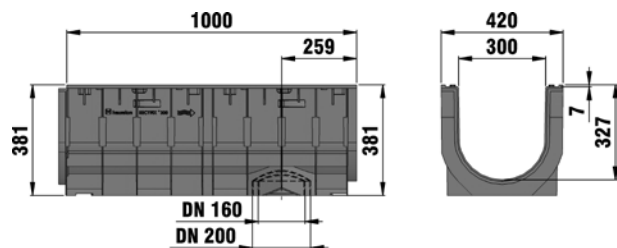
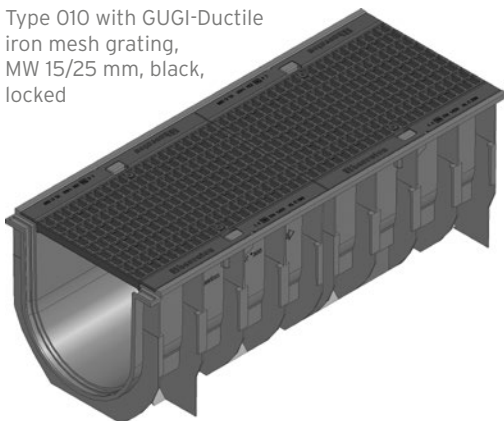

	Length mm	Width mm	Height mm	Internal channel cross-sect. cm ²	Intake cross-sect. cm ² /m	Weight kg	Item No.
Type 01 with GUGI-Ductile iron mesh grating, MW 15/25 mm, black, locked	1000	352	292	725	1385	30,40	40870
Type 010 with GUGI-Ductile iron mesh grating, MW 15/25 mm, black, locked	1000	420	381	857	1385	35,70	40875

RECYFIX® STANDARD 300

Accessories

Trash boxes

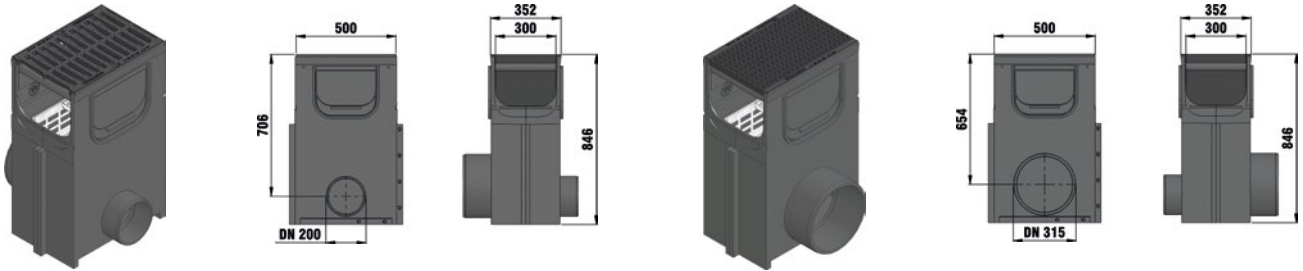

Trash box with galvanised mud bucket and ductile iron grating SW 2 x 127/18 mm, black, class B 125, locked, with PVC-U pipe outlet DN/OD 200

Trash box with galvanised mud bucket and GUGI-Ductile iron mesh grating, MW15/25 mm, only suitable for type O1, black, class C 250, locked, with PVC-U pipe outlet DN/OD 315

	Length mm	Width mm	Height mm	Weight kg	Item No.
Trash box with galvanised mud bucket and ductile iron grating SW 2 x 127/18 mm, black, class B 125, locked, with PVC-U pipe outlet DN/OD 200	500	352	846	45,50	32865
Trash box with galvanised mud bucket and ductile iron grating SW 2 x 127/18 mm, black, class B 125, locked, with PVC-U pipe outlet DN/OD 315	500	352	846	45,50	32866
Trash box with galvanised mud bucket and GUGI-Ductile iron mesh grating, MW 15/25 mm, only suitable for type O1, black, class C 250, locked, with PVC-U pipe outlet DN/OD 200	500	352	846	49,10	32328
Trash box with galvanised mud bucket and GUGI-Ductile iron mesh grating, MW 15/25 mm, only suitable for type O1, black, class C 250, locked, with PVC-U pipe outlet DN/OD 315	500	352	846	49,10	32335

RECYFIX®
PRO

RECYFIX®
PLUS

RECYFIX®
STANDARD

Facade Drainage

SLOTTED
CHANNELS

RECYFIX® POINT
FASERFIX® POINT

RECYFIX®
GREEN

LINEFIX

TOP X

RECYFIX® STANDARD 300

Accessories

End caps



End cap closed, galvanised, type 01

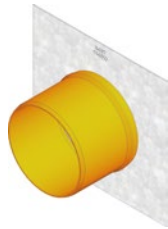

End cap with horizontal PVC-U pipe outlet galvanised, type 01

	Length mm	Width mm	Height mm	Weight kg	Item No.
End cap closed, galvanised, type 01	-	360	340	1,80	40882
End cap closed, galvanised, type 010	-	420	380	2,80	40881
End cap with horizontal PVC-U pipe outlet galvanised, type 01	-	360	340	2,30	40892
End cap with horizontal PVC-U pipe outlet DN/OD 200, galvanised, type 010	-	420	380	3,10	40891

Further accessories

	Length mm	Width mm	Height mm	Weight kg	Item No.
Universal sealant/adhesive Siga-Meltell® 220 black**	-	-	-	1,00	19051
Tubular pistol for universal sealant/adhesive Siga-Meltell® 220 black**	-	-	-	1,30	6891

****Amount needed for Type 01: approx. 29 ml per joint**

Grating options
RECYFIX STANDARD 150

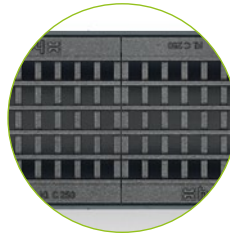

GUGI ductile iron gratings

Mesh width: 15 x 25 mm

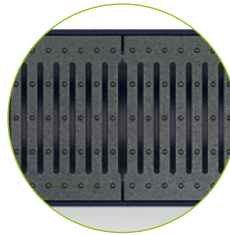

Ductile iron gratings

Slot width: 130 x 6 mm

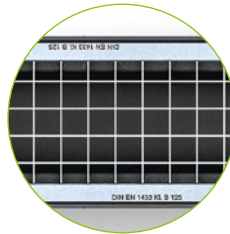
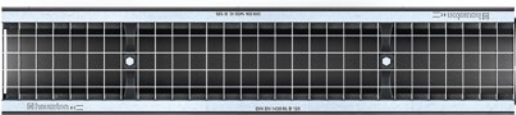

Mesh gratings, galvanised

Mesh width: 30 x 30 mm

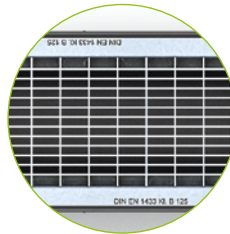

Mesh gratings, galvanised

Mesh width: 30 x 10 mm

RECYFIX® PRO
RECYFIX® PLUS
RECYFIX® STANDARD
Facade Drainage
SLOTTED CHANNELS
RECYFIX® POINT FASERFIX® POINT
RECYFIX® GREEN
LINEFIX
TOP X

RECYFIX® STANDARD 150

Combi article

RECYFIX® STANDARD 150, class B 125

Type 01 with mesh grating
MW 30/30 mm, galvanised,
locked

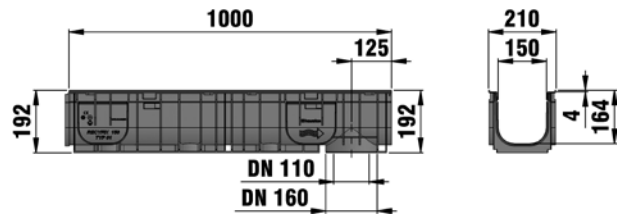
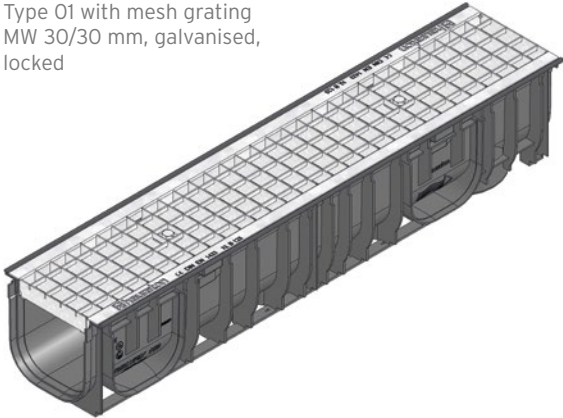

Type 100 with mesh grating
MW 30/30 mm, galvanised,
locked

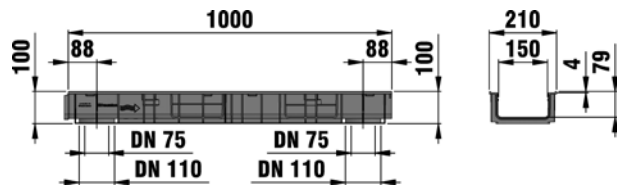
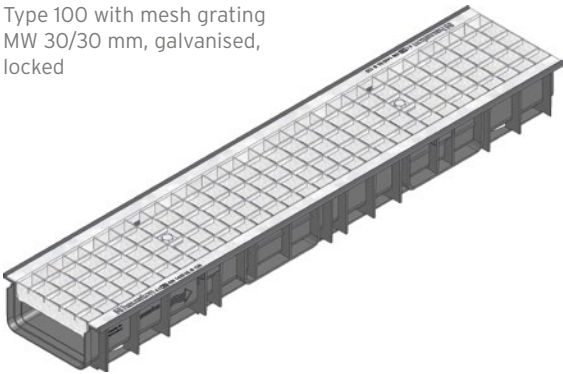

	Length mm	Width mm	Height mm	Internal channel cross-sect. cm ²	Intake cross-sect. cm ² /m	Weight kg	Item No.
Type 01 with mesh grating MW 30/30 mm, galvanised, locked	1000	210	192	225	1081	7,70	40171
Type 0105 with mesh grating MW 30/30 mm, galvanised, locked	500	210	192	225	1081	7,80	40146
Type 100 with mesh grating MW 30/30 mm, galvanised, locked	1000	210	100	116	1081	6,80	40135
Type 01 with mesh grating MW 30/10 mm, galvanised, locked	1000	210	192	225	1098	9,00	40177
Type 0105 with mesh grating MW 30/10 mm, galvanised, locked	500	210	192	225	1098	4,50	40148
Type 100 with mesh grating MW 30/10 mm, galvanised, locked	1000	210	100	116	1098	7,80	40136

RECYFIX® STANDARD 150

RECYFIX® STANDARD 150, class C 250

Type 100 with ductile iron grating black, SW 6 mm, locked

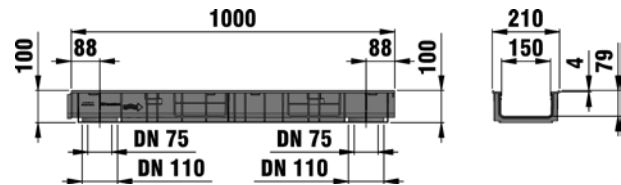
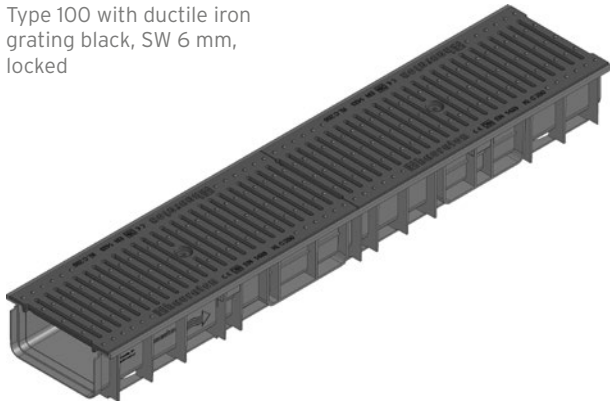

Type 01 with GUGI-Ductile iron mesh grating MW 15/25 mm, black, locked

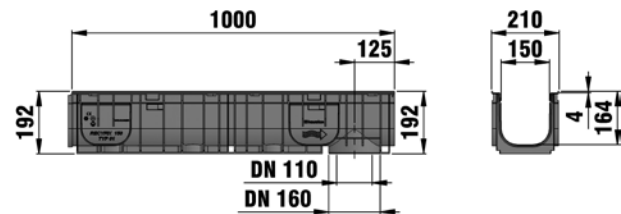
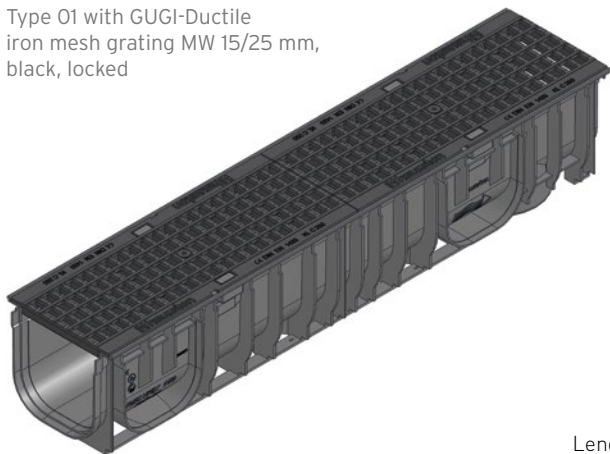

	Length mm	Width mm	Height mm	Internal channel cross-sect. cm ²	Intake cross-sect. cm ² /m	Weight kg	Item No.
Type 01 with ductile iron grating black, SW 6 mm, locked	1000	210	192	225	400	14,00	40176
Type 0105 with ductile iron grating black, SW 6 mm, locked	500	210	192	225	400	6,60	40150
Type 100 with ductile iron grating black, SW 6 mm, locked	1000	210	100	116	400	13,00	40137
Type 01 with GUGI-Ductile iron mesh grating MW 15/25 mm, black, locked	1000	210	192	225	745	12,40	40174
Type 0105 with GUGI-Ductile iron mesh grating MW 15/25 mm, black, locked	500	210	192	225	745	6,00	40149
Type 100 with GUGI-Ductile iron mesh grating MW 15/25 mm, black, locked	1000	210	100	116	745	11,60	40141

RECYFIX®
PRO

RECYFIX®
PLUS

RECYFIX®
STANDARD

Facade Drainage

SLOTTED
CHANNELS

RECYFIX® POINT
FASERFIX® POINT

RECYFIX®
GREEN

LINEFIX

TOP X

RECYFIX® STANDARD 150

Accessories

Trash boxes

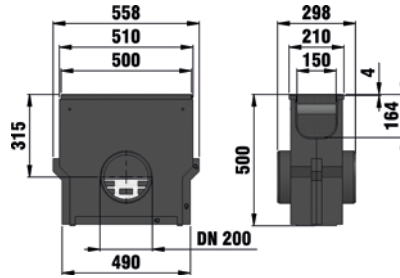
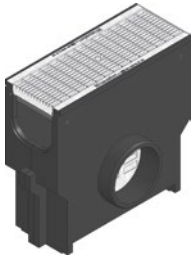

Trash box with galvanised bucket, with mesh grating MW 30/10 mm, galvanised, class B 125, locked



Trash box with galvanised bucket with GUGI-Ductile iron mesh grating MW 15/25 mm, black, class C 250, locked

	Length mm	Width mm	Height mm	Weight kg	Item No.
Trash box with galvanised bucket, with mesh grating MW 30/30 mm, galvanised, class B 125, locked	500	210	500	20,00	40154
Trash box with galvanised bucket, with mesh grating MW 30/10 mm, galvanised, class B 125, locked	500	210	500	17,90	40156
Trash box with galvanised bucket with GUGI-Ductile iron mesh grating MW 15/25 mm, black, class C 250, locked	500	210	500	20,00	40153
Trash box with galvanised mud bucket, with ductile iron grating black, SW 6 mm, locked	500	210	500	20,10	40157

RECYFIX® STANDARD 150

End caps

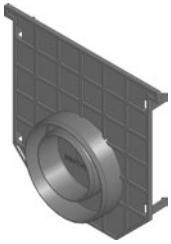

End cap combined made of PP with outlet DN/OD 75/110, type 01



End cap closed, type 100

	Length mm	Width mm	Height mm	Weight kg	Item No.
End cap combined made of PP with outlet DN/OD 75/110, type 01	-	210	203	0,10	40191
End cap closed, type 100	-	208	100	0,00	40190

Further accessories



Foul air trap, vertical, DN/OD 110

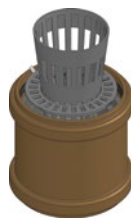

Foul air trap set, vertical DN/OD 110 for RECYFIX 100

	Length mm	Width mm	Height mm	Weight kg	Item No.
Mud bucket vertical made of modified composite for outlet DN/OD 160, black	-	-	-	0,10	845
Foul air trap, vertical, DN/OD 110	-	187	181	0,60	40295
Foul air trap set, vertical DN/OD 110 for RECYFIX 100	-	-	203	0,40	40294
Universal sealant/adhesive Siga-Meltell® 220 black**	-	-	-	1,00	19051
Tubular pistol for universal sealant/adhesive Siga-Meltell® 220 black**	-	-	-	1,30	6891
Holesaw, Ø 102 mm, with tool holder for a drill	-	-	-	0,60	980

****Amount needed for Type 01: approx. 17 ml per joint**

RECYFIX®
PRO

RECYFIX®
PLUS

RECYFIX®
STANDARD

Facade Drainage

SLOTTED
CHANNELS

RECYFIX® POINT
FASERFIX® POINT

RECYFIX®
GREEN

LINEFIX

TOP X